



**Model UHF-R® Wireless User Guide . . . . . 5**



**! IMPORTANT SAFETY INSTRUCTIONS !**

1. READ these instructions.
2. KEEP these instructions.
3. HEED all warnings.
4. FOLLOW all instructions.
5. DO NOT use this apparatus near water.
6. CLEAN ONLY with dry cloth.
7. DO NOT block any ventilation openings. Install in accordance with the manufacturer's instructions.
8. DO NOT install near any heat sources such as radiators, heat registers, stoves, or other apparatus (including amplifiers) that produce heat.
9. DO NOT defeat the safety purpose of the polarized or grounding-type plug. A polarized plug has two blades with one wider than the other. A grounding type plug has two blades and a third grounding prong. The wider blade or the third prong are provided for your safety. If the provided plug does not fit into your outlet, consult an electrician for replacement of the obsolete outlet.
10. PROTECT the power cord from being walked on or pinched, particularly at plugs, convenience receptacles, and the point where they exit from the apparatus.
11. ONLY USE attachments/accessories specified by the manufacturer.
12.  USE only with a cart, stand, tripod, bracket, or table specified by the manufacturer, or sold with the apparatus. When a cart is used, use caution when moving the cart/apparatus combination to avoid injury from tip-over.
13. UNPLUG this apparatus during lightning storms or when unused for long periods of time.
14. REFER all servicing to qualified service personnel. Servicing is required when the apparatus has been damaged in any way, such as power-supply cord or plug is damaged, liquid has been spilled or objects have fallen into the apparatus, the apparatus has been exposed to rain or moisture, does not operate normally, or has been dropped.
15. DO NOT expose the apparatus to dripping and splashing. DO NOT put objects filled with liquids, such as vases, on the apparatus.



This symbol indicates that dangerous voltage constituting a risk of electric shock is present within this unit.



This symbol indicates that there are important operating and maintenance instructions in the literature accompanying this unit.

**WARNING:** Voltages in this equipment are hazardous to life. No user-serviceable parts inside. Refer all servicing to qualified service personnel. The safety certifications do not apply when the operating voltage is changed from the factory setting.

## Contents

---

Important Safety Instructions . . . . .	3
Feature Overview . . . . .	6
System Components . . . . .	7
Receiver Controls and Connectors . . . . .	8
Receiver LCD Interface . . . . .	9
Receiver Parameters . . . . .	9
Automatic Frequency Selection . . . . .	11
Networking Receivers . . . . .	12
Handheld and Bodypack Transmitter Controls and Connectors . . . . .	13
Transmitter LCD Interface . . . . .	13
Transmitter Batteries . . . . .	13
Transmitter Parameters . . . . .	14
Setting Transmitter Gain . . . . .	14
RF Safety Mode . . . . .	14
Automatic Transmitter Sync . . . . .	15
Troubleshooting . . . . .	16
Specifications . . . . .	17
Replacement Parts and Accessories . . . . .	19
UHF-R Wireless System Compatibility Guide . . . . .	69

## Feature Overview

The UHF-R<sup>®</sup> Wireless Microphone System uses the latest wireless technology, delivers outstanding audio clarity, and is rugged and reliable. It is easy to set up and operate with advanced features for professional installations requiring multiple wireless microphone systems.

### Frequency Band Selection

Shure offers wireless systems in a selection of *bands* that conform to the different government regulations of specific nations or geographic regions. These regulations help limit radio frequency (RF) interference among different wireless devices and prevent interference with local public communications channels, such as television and emergency broadcasts.

The system's band and frequency range are identified on the face of the receiver and transmitter. For example, "H4 518–578 MHz."

For information on bands available in your area, consult your local dealer or phone Shure. More information is also available at Shure's website ([www.shure.com](http://www.shure.com)).

### Groups and Channels

To transmit audio through a wireless system, the transmitter and receiver must be set to the same radio frequency, or *channel*. A wide selection of channels allows more microphones to be used at the same time, since each microphone must operate on a different channel. It also provides a greater choice of *open channels*—those that are free from interference from television broadcasts, electronic devices, or other wireless systems.

A *group* is a selection of compatible channels. Wireless microphones work better together when set to channels in the same group.

### Automatic Frequency Selection

The following features scan the RF environment to find the best group and channel settings for a particular installation.

- **Group Scan**—finds the group with the most open channels, then sets all networked receivers to channels in that group.
- **Channel Scan**—finds the first open channel in the currently selected group and sets the receiver to that channel.

Follow the steps on page 11 for instructions on using these features.

### Automatic Transmitter Sync

This feature automatically transfers the group and channel settings from a receiver to a transmitter. You can also program other transmitter settings on a receiver and transfer those settings too. See page 15.

### Interface Lock

This feature locks the receiver and transmitters so that users cannot change settings. The transmitter power switch can also be disabled so that the transmitter remains on if the power switch is accidentally toggled during a performance.

### Audio Gain Structure

The following settings allow you to adjust audio gain throughout the system:

- **Sensitivity** (bodypack only). A 25 dB range of gain adjustment at the bodypack transmitter input.
- **Transmitter Gain**. A 30dB range of audio gain adjustment within the transmitter (affects audio level at the receiver, as indicated by the **Audio** LEDs.)
- **Output Level**. 32 dB of attenuation at the receiver output, plus a mute setting.
- **Mic/Line switch**. –30 dB pad for matching audio levels at the receiver XLR output.

### Networking

Each receiver has an RJ-45 port on the back for connecting to other receivers over an Ethernet network. Networking receivers allows you to automatically set channels for all the receivers with a single group scan command. You can also control and monitor all networked receivers through the Shure Wireless Workbench PC software.

### Shure Wireless Workbench Software

The Shure Wireless Workbench software on the supplied CD includes a variety of useful tools for installing and managing multiple wireless systems. Simply install the software on your computer and connect it to a network of receivers to monitor and control receivers and transmitters throughout the network. (See page 12 for more information on networking.)

Instructions on using the Wireless Workbench software are available in the online help files after you install the software.

# System Components

## All systems include:

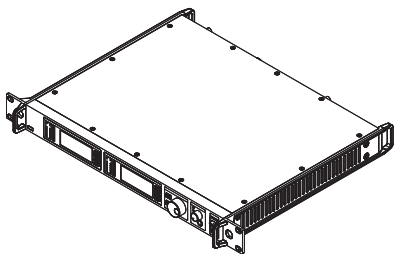

UR4S or UR4D Receiver  
(UR4D pictured)

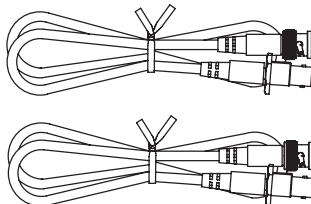

Two Antenna Cables

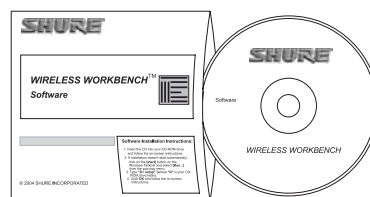

Shure's Wireless Workbench Software



Two 1/2 Wave Antennas

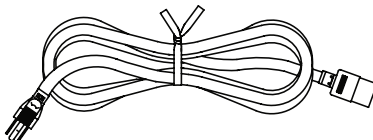

IEC Power Cable

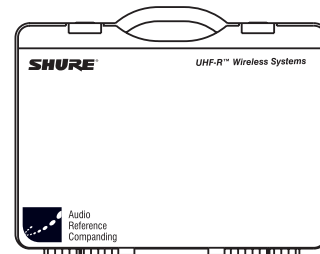

Transmitter Carrying Case

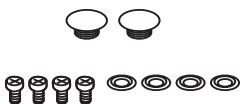

2 Antenna hole plugs  
4 Rack Mount Screws with Washers

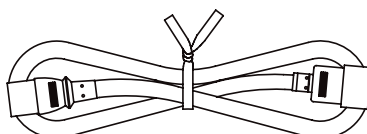

IEC Power Extension Cable



AA Batteries

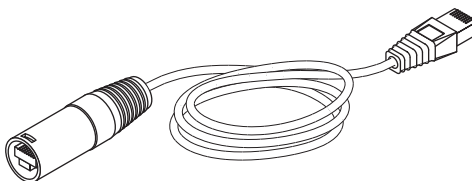

Ethernet Network Cable with "Ruggedized" plug

## Handheld Systems Include:

- 1 Microphone Head (choice of SM58®, SM86, Beta 58A®, Beta 87A™, Beta 87C™ or KSM9/BK, KSM9/SL)
- 2 UR2 handheld transmitter
- 3 Microphone clip

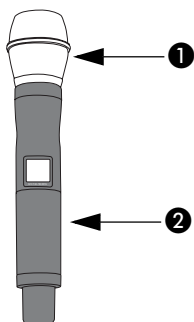

## Bodypack Systems Include:

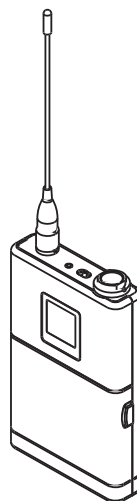

UR1 Bodypack Transmitter

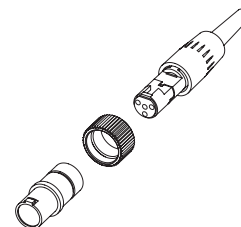

Threaded TA4F Adapter

## Receiver Controls and Connectors

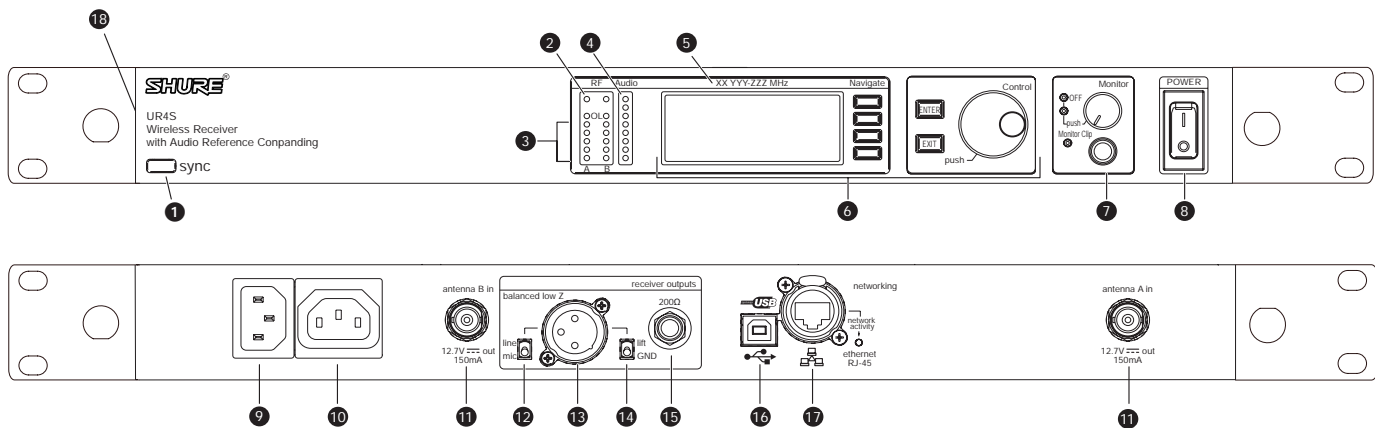

- 1 **SYNC** Infrared (IR) port. Transmits group, channel, and other settings to a transmitter. See page 15.
- 2 **Squelch** LEDs.
  - Blue (On) = Transmitter signal detected
  - Off = no signal or signal squelched because of poor reception or no tonekey

**NOTE:** The receiver will not output audio unless at least one blue LED is illuminated.
- 3 **RF** LEDs. Indicate RF signal strength from the transmitter at each antenna and diversity condition.
  - Amber = normal
  - Red = overload (greater than  $-25$  dBm)
- 4 **Audio** LEDs. Indicate audio signal strength from transmitter.
  - Green = signal present
  - Yellow = normal peak
  - Red = overload

To correct this level, adjust the transmitter gain.
- 5 Indicates the name and range of receiver frequency band.
- 6 **LCD** Interface. Provides a convenient way to program the receiver from the front panel (see detail on next page).
- 7 **Monitor**. 1/4" output jack and volume knob for headphones.
  - **Monitor clip** LED indicates headphone audio is clipping.
  - **Dual models:** Push the knob to switch from receiver one to receiver two.
- 8 **Power** switch. Powers the unit on and off.
- 9 AC mains power input, IEC connector. 100–240 Vac.
- 10 AC mains power passthrough (unswitched). Use with an IEC extension cable to supply AC power to another device.
- 11 Diversity antenna inputs A and B.
 

**Note:** Antenna inputs are DC biased. Use only antenna combiners and accessories listed in page 19. Some types of antenna splitters or other products may short the DC power and damage the receiver.
- 12 **Mic/Line** switch. Changes output level  $-30$  dB (XLR output only).
- 13 Electrically balanced XLR output jack
- 14 **Lift/GND** switch. Lifts ground from Pin 1 of the XLR connector (default = **GND**).
- 15 Impedance balanced 1/4" output jack (200 $\Omega$ )
- 16 USB jack for computer interface.
- 17 RJ-45 jack for Ethernet network interface. Accepts both regular and "ruggedized" RJ-45 plugs.
- 18 Temperature-activated fan ensures top performance in high temperature environments. Clean fan screen as needed to remove dust.

## Receiver LCD Interface

### Menu Access

Press the **NAVIGATE** key next to the menu item you want to select.

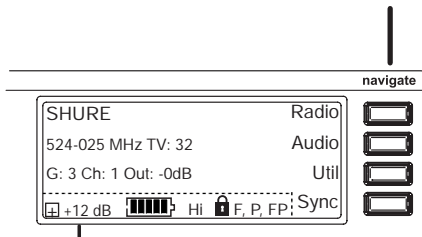

### Transmitter Status Display

Everything under the dotted line reflects the settings for the transmitter, if present. (main title screen only).

### Accept Changes

After changing a parameter, the **ENTER** button flashes. Press it to save the value.

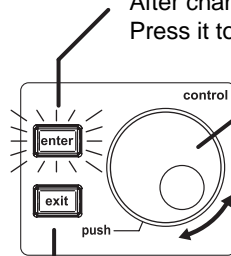

### Cursor Control

Push the **CONTROL** wheel to move the cursor to the next item.

Turn the **CONTROL** wheel to change a parameter value.

### Exit/Cancel

Press the **EXIT** button to cancel changes and return to the previous menu.

## Receiver Parameters

Use the following instructions to set parameters through the LCD interface.

**NOTE:** After adjusting a parameter, you must press the flashing **ENTER** button to accept the change.

### Group and Channel

Menu: Radi o

- Push the **CONTROL** wheel to move the cursor to the Group (G) or Channel (Ch) parameter.
- Turn the **CONTROL** wheel to change the parameter.

### Frequency

Menu: Radi o

- Push the **CONTROL** wheel to move the cursor to the integer value (741. 000 MHz) or fractional value (741. 025).
- Turn the **CONTROL** wheel to change the value.

### Automatic Transmitter Sync

Menu: Sync

- See page 15.

### Receiver Name

Menu: Util

- Turn the **CONTROL** wheel to change the letter.
- Push the **CONTROL** wheel to move to the next letter.

### Output Level

Menu: Audi o

This setting adjusts the signal level at the XLR and 1/4" audio output jacks.

- Turn the **CONTROL** wheel to change the relative level in dB. (0 dB to -32 dB).

- Turn the wheel all the way down to mute the outputs.

### Squelch

Menu: Radi o > Squel ch

- Turn the **CONTROL** wheel to change the parameter

### Receiver Lock

When locked, the receiver settings cannot be changed from the front panel. However, you can still navigate the LCD menu to view the settings (and turn the lock off).

Menu: Util > Lock

- Turn the **CONTROL** wheel to toggle the lock on or off (ON or OFF).

### LCD View

Menu: Util > Title

- Turn the **CONTROL** wheel to mark an item for display.
- Push the **CONTROL** wheel to move to the next item.

### LCD Contrast

Menu: Util > Contrast

- Turn the **CONTROL** wheel to increase or decrease contrast.

### Tonekey

Menu: Radi o > Squel ch > Tonekey

Tonekey squelch mutes the outputs unless the receiver detects a transmitter. Tonekey should be left on (On) except for certain troubleshooting operations.

## Network Parameters

### NOTE:

- The receiver reboots after you press **ENTER** to accept network parameter changes
- In dual models (UR4D), these settings affect *both* receivers (the dual receiver is treated as a single network device).

### Set the Receiver Network Mode

Menu: **Uti l > Network**

1. Push the **Control** wheel to move the cursor to the **Mode** parameter.
2. Turn the **Control** wheel to set the receiver to one of the following values:
  - **DHCP**: use this setting when connecting the receiver to a DHCP server.
  - **Manual** : allows you to set the receiver to a specific IP address or subnet.

### IP Address and Subnet

Menu: **Uti l > Network**

**NOTE:** To change these settings, the network mode must be set to **Manual** .

1. Push the **Control** wheel to move the cursor to any of the following parameters:
  - **I P** (IP address)
  - **Sub** (Subnet mask)
2. Turn the **Control** wheel to change the value.

## Device ID

Assists in identifying receivers through the Wireless Workbench Software (has no effect on network identification).

Menu: **Uti l > Network**

1. Push the **Control** wheel to move the cursor to the **Dev I D** parameter.
2. Turn the **Control** wheel to set the receiver to change the value.

## Custom Groups

This feature allows you to create your own groups of frequencies.

### Creating new groups...

Menu: **Radi o > Custom**

1. Turn the **Control** wheel to select a custom group number (U1, U2, U3, etc.)
2. Push the **Control** wheel to move to the **Channel** parameter and turn it to select a channel (O1, O2, O3, etc.)
3. Push the **Control** wheel to move to the **Fr eq** parameter and select a frequency for that channel.
4. Push the **NEXT** menu key to select a frequency for the next channel in that group.

## Automatic Frequency Selection

Follow these steps to use the channel scan and group scan features.

### Before you begin...

- Install the receivers in the location where they will be used and power them on.
- Mute all inputs on mixing devices connected to receivers.
- Turn off all bodypack or handheld transmitters for the systems you are setting up.
- *Turn on potential sources of interference* such as other wireless systems or devices, computers, CD players, effects processors, and digital rack equipment so they are operating as they would be during the presentation or performance.

### Single Receiver

1. Select Radi o > Scan > Chan Scan using the **Navigate** keys on the receiver LCD interface.
2. **Turn** the **control** wheel to select a group.
3. Press Chan Scan. The display indicates that the receiver is searching. Once it has finished, it displays the selected channel.
4. Press the flashing **ENTER** button to accept the suggested channel.
5. Sync the transmitter (see page 15).

### Networked or Dual Receivers

With networked or dual receivers, you can take advantage of the group scan feature to set group and channel settings for all the receivers at the same time. (See page 12 for instructions on networking.)

#### **Perform a group scan from any receiver...**

1. Select Radi o > Scan > Group Scan using the **Navigate** keys on the receiver LCD interface. The display indicates that the receiver is searching (Scan In Progress). Once it has finished, it displays the group with the most open channels.
2. If you wish, turn the **control** wheel to change groups. The number of open channels for each group is displayed.
3. Press the flashing **ENTER** button to set all receivers to open channels in that group.

**NOTE:** The group scan feature only works for receivers in the same frequency band. For example, if you did a group scan on a “H4” band receiver, all “H4” band receivers would be set up, but not “J5” band receivers.

### Multiple Receivers—Not Networked

If your receivers are not networked (or in different bands), the group scan cannot automatically set their group and channel settings. However, you can still take advantage of the group scan feature to find the group with the most open channels and the channel scan feature to find open channels in that group.

#### **Find the group with the most open channels...**

Perform a group scan using the steps for a networked receiver (above). However, *make a note of the selected group* before pressing the flashing **ENTER** button to accept it.

#### **Set the receivers to open channels in that group...**

Perform a channel scan on the remaining receivers using the steps for a single receiver (above). Make sure to select the same group for each receiver before performing the channel scan.

**IMPORTANT:** After setting the channel for the first receiver, immediately sync the transmitter for that receiver and leave it on so that the next receiver detects that channel during its channel scan. Otherwise, all the receivers will be set to the same open channel.

**NOTE:** Receivers in different bands (H4, J5, L3, etc.) do not need to be set to the same group.

# Networking Receivers

## Basic Network

Connect receivers to an Ethernet router with DHCP service. Use Ethernet switches to extend the network for larger installations.

Use the receiver's default network setting (Uti I > Network > Mode = DHCP).

## Accessing the Network with a Computer

If you want to use the Wireless Workbench software, connect your computer to the network and install the software from the CD that came with the receiver. Make sure your computer is configured for DHCP (from *Control Panel*, click *Network Connections*. Double-click on *Local Area Connection*. Select *Internet Protocol (TCP/IP)* and click *Properties*. Select *Obtain IP address automatically* and *Obtain DNS server address automatically* and click OK).

**NOTE:** Some security software or firewall settings on your computer can prevent you from connecting to the receivers. If using firewall software, allow connections on port 2201.

### Using USB...

Connect the computer to the USB port on any of the receivers to access the whole network.

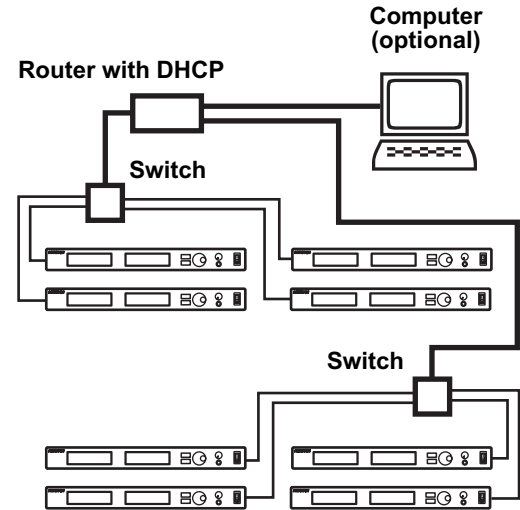
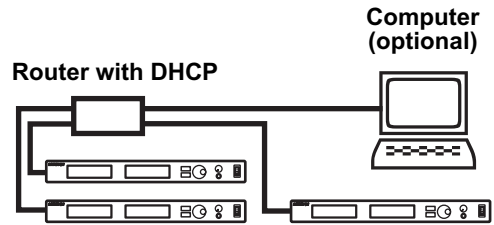
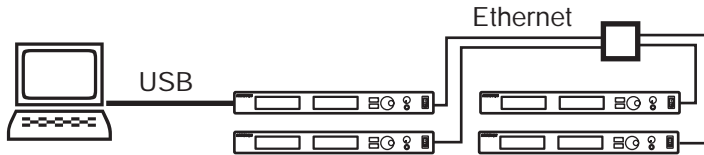

## Static IP Addressing

The receiver also supports static IP addressing. Assign your own IP addresses ( Uti I > Network > Mode = Manual ). See "Network Parameters" on page 10.

**NOTE:** Dual receivers use a single IP address, which may be set through either LCD interface.

## Existing UHF Network Installations

Both Shure's UHF-R receivers and legacy UHF receivers can be networked to the same PC and accessed using the latest Wireless Workbench software.

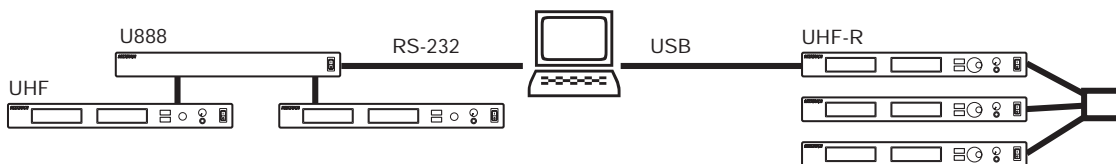

## Handheld and Bodypack Transmitter Controls and Connectors

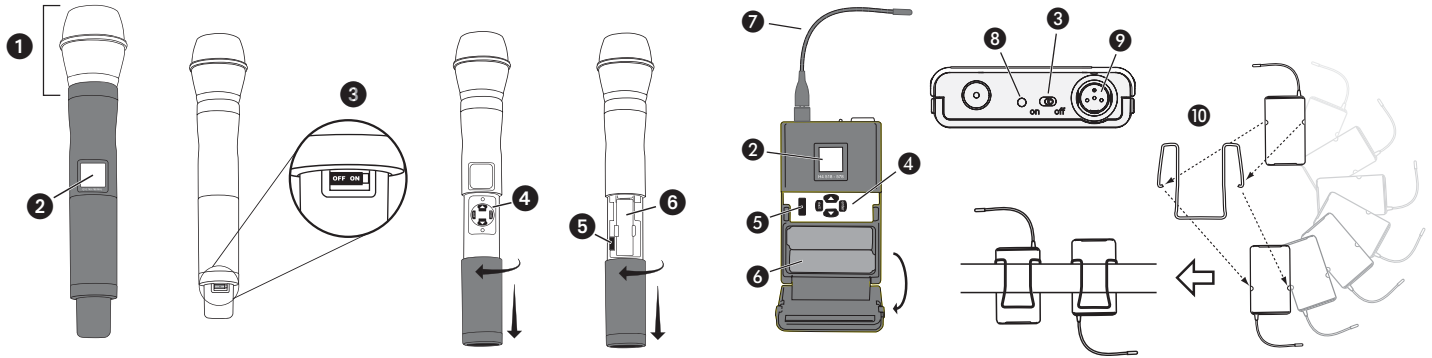

- ① Interchangeable microphone head (BETA 87A pictured).
- ② LCD Panel.
- ③ Power Switch.
- ④ Control buttons for LCD interface.
- ⑤ Infrared (IR) port. See page 15.
- ⑥ Battery compartment.
- ⑦ Flexible Antenna.
- ⑧ Power LED.
- ⑨ 4-Pin Microphone Input Jack.
- ⑩ Reversible Belt Clip.

## Transmitter LCD Interface

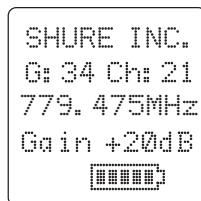

Main Menu

**exit Key.** Move to the left, or exit without saving changes.

**Up Arrow Key.** Scroll up or increase a value.

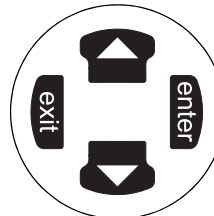

**enter Key.** Press to select parameters and accept the selected value.

**Down Arrow Key.** Scroll down or decrease a value.

## Transmitter Batteries

Transmitters operate on standard AA batteries. Turn off the transmitter before changing the batteries.

The battery fuel gauge displayed on the transmitter LCD gives an indication of remaining battery life, as shown below.

Transmitter Display	Approximate Hours Remaining (alkaline batteries)	
	Normal Power	High Power*
	7.5 to 9.5	5 to 6
	5.75 to 7.5	4 to 5
	4 to 5.75	3 to 4
	2 to 4	1.5 to 3
	15 minutes to 2 hours	10 minutes to 1.5

\* High power setting not available with models sold in countries that prohibit its use.

## Transmitter Parameters

Press **ENTER** from the main menu to access the following parameters:

```
G: 34 Ch: 21
779.475MHZ
Gain +20dB
SHURE INC.
```

**Group (G) and Channel (Ch).** Must match the receiver's settings.

**Frequency (MHz).** Manual frequency selection in 0.025 MHz increments.



**Gain (Gain).** Adjusts audio level from -10 dB to +20 dB.



**Sensitivity (Sens)** (bodypack only).



Sets audio input to +15 dB, 0 dB, or -10 dB.



**Name Display.** 12-digit ASCII.

Use the following key combinations to access additional features and parameters:

hold tap  
 +  **LCD Panel**  
 Changes LCD Panel

hold tap  
 +  **Frequency Lock**  
 Toggles setting. When enabled, frequency cannot be changed, and a transmitter sync *will not* overwrite the frequency setting.

hold tap  
 +  **Power Lock**  
 Toggles power lock. When locked, power switch does not turn off transmitter.

hold tap  
 +  **RF power level setting\***  
 Use the arrow keys to select normal (10 mW) or high power (50/100 mW\*\*). Use the normal power setting to conserve batteries or prevent RF overload at the receiver.

\* High power setting not available with models sold in countries that prohibit its use.

\*\* High power value varies with model.

## Lock Indicators

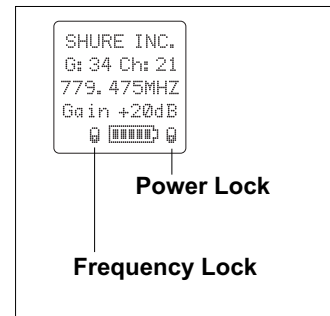

## Setting Transmitter Gain

Adjust the transmitter gain and input sensitivity so that the **Audio** LEDs on the receiver peak within the yellow range during use. On the bodypack transmitter, you can change the sensitivity setting to compensate for different audio levels when connecting different instruments or microphones to the input.

To adjust gain, turn on the transmitter and press the **enter** button. Scroll down to the **Gain** parameter or the **Sens** parameter (bodypack only) and press **enter** again. Use the arrow keys to adjust the setting and press **enter** to save it (**Exit** cancels without saving).

## RF Safety Mode

This special feature temporarily mutes RF broadcast. This allows you to change frequency settings on a transmitter without accidentally “cutting in” on a channel being used by another transmitter.

1. Turn the transmitter off.
2. Hold down **exit** key while turning on the transmitter power (for handheld microphones, you need to pull the battery cover off the handle). The LCD flashes while the unit is in RF safety mode.
3. Change group and channel settings as you normally would—the transmitter will not broadcast.
4. Power the transmitter off and on to exit RF safety mode.

## Automatic Transmitter Sync

This feature automatically updates a bodypack or handheld transmitter's group and channel settings to match those of a selected receiver.

### To perform a transmitter sync...

1. Open the transmitter battery cover to display the infrared (IR) port.
2. With the IR port exposed to the receiver, select **Sync > sync** from the receiver LCD interface.

The display on the receiver indicates whether the sync was successful. If the sync fails, try again, making sure that the IR port on the transmitter is exposed and directly faces the IR port on the receiver.

**NOTE:** Close the battery door before performing a sync on other transmitters.

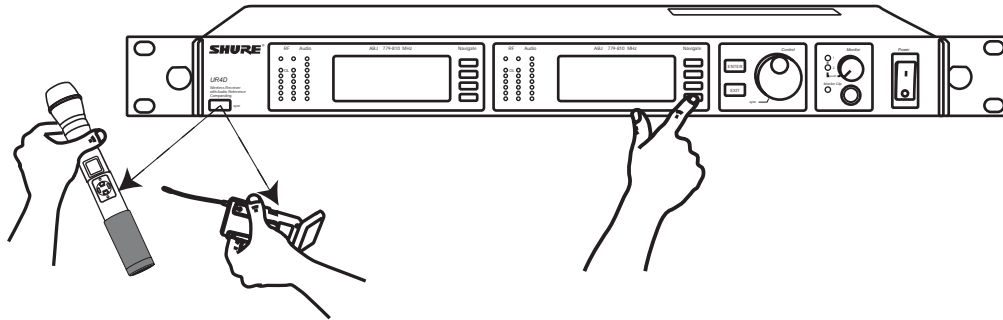

### To transfer other transmitter settings...

Optionally, you can transfer other transmitter settings from a receiver when you perform a sync. Use the following steps:

1. Select **Sync > Setup** from the receiver LCD interface.
2. Turn the **Control** wheel to change parameter settings.
3. Push the **Control** wheel to move to the next parameter.
4. Push the flashing **ENTER** button to save the settings.

The transmitter settings you set on the receiver remain for future syncs.

**NOTE:** If you don't want the sync to send a setting, set the parameter to **No Change**

### Available Settings...

The following settings are available from the **Sync > Setup** menu:

- Sensitivity (Sens) bodypack only
- Gain (Gain)
- RF Power (Pwr)
- Power and Frequency Lock (Lock), which has the following values:
  - Power lock only: (Pwr Only)
  - Frequency lock only: (Freq only)
  - Both: (Freq and Pwr)
  - Neither: (Unlocked)
- Custom Groups (CG):
  - On (ON): Send custom groups to transmitters during sync
  - Off (OFF): Do not send custom groups (reduces sync time)

## Troubleshooting

Issue	See Solution...
No sound	Power, Cables, or RF
Faint Sound or Distortion	Gain
Lack of range, unwanted noise bursts, or drop outs	RF
Cannot turn transmitter off or change frequency settings, or can't program receiver	Interface Locks
Excessive hum or buzzing	Ground lift

### Power

Make sure that the transmitter and receiver are receiving sufficient voltage. The receiver requires at least 90 Vac. Check the battery indicator on the transmitter and replace battery if necessary.

### Gain

Adjust the transmitter gain and sensitivity settings (see page 14) or the receiver output level (page 9), or toggle the **mic/line** switch on the back of the receiver.

### Cables

Check that all cables and connectors are in working order.

### Ground Lift

Lifting the ground on pin 1 of the XLR output on the receiver can sometimes remove hum or buzz in the audio signal. Set the **GND/LIFT** switch on the receiver to **LIFT** if you are using the XLR connector.

### Interface Locks

Both the transmitter and receiver can be locked to prevent accidental changes. On transmitters, look for a lock symbol on the LCD and use the key combinations illustrated on page 14 to turn it off.

To turn off the receiver interface lock, see page 9.

### Radio Frequency (RF)

#### Using the RF LEDs

If neither blue **RF** LED is illuminated, then the receiver is not detecting the presence of a transmitter.

The amber **RF** LEDs indicate the amount of signal being received. This signal could be from the transmitter, or it could be from an interfering source, such as a television broadcast. Turn the transmitter off. If more than one or two of the amber **RF** LEDs are still illuminated, then that channel has too much interference, and you should try a different channel.

The red **RF** LED indicates RF overload. This will usually not cause a problem unless you are using more than one system at the same time, in which case, it can cause interference between systems.

#### Compatibility

- Perform a transmitter sync, or make sure the transmitter and receiver are set to the same group and channel.
- Look at the label on the transmitter and receiver to make sure they are in the same band (H4, J5, L3, etc...).

#### Reducing Interference

- Use a different channel or perform an automatic group or channel scan (see page 11).
- For multiple systems, check that all systems are set to channels in the same group (systems in different bands do not need to be set to the same group).
- Maintain a line of sight between transmitter and receiver antennas
- Move receiver antennas away from metal objects or other sources of RF interference (such as CD players, computers, digital effects, network switches, network cables and Personal Stereo Monitor (PSM) wireless systems).
- Eliminate RF overload (see below).

#### Increasing Range

If the transmitter is more than 6 to 60 m (20 to 200 ft) from the receiver antenna, you may be able to increase range by doing one of the following:

- Reduce interference (see above)
- Increase transmitter RF power level (see page 14).
- Use an active directional antenna, antenna distribution system, or other antenna accessory to increase RF range (see page 19).

#### Eliminating RF Overload

If you see the red **RF** LED on a receiver, reduce the transmitter RF power level (see page 14) or move the transmitter further away from the receiver—at least 6 m (20 ft). If you are using active antennas, reduce antenna or amplifier gain.

# Specifications

## Frequency Range and Transmitter Output Power

Band	Range	Transmitter power (mW)	
		Handheld	Bodypack
<b>H4E, H4</b>	518-578 MHz	10 / 50 10 / 50	10 / 50 10 / 100
<b>J5E, J5</b>	578-638 MHz (578-608, 614-638)	10 / 50 10 / 50	10 / 50 10 / 100
<b>L3E, L3</b>	638-698 MHz	10 / 50 10 / 50	10 / 50 10 / 100
<b>Q5</b>	740-814 MHz	10 / 50	10 / 50
<b>R9</b>	790-865	10 / 50	10 / 50
<b>Q6</b>	740-752 MHz	10	10
<b>A24</b>	779-788 / 797-806 MHz	10	10
<b>JBX</b>	806-810 MHz	10	10
<b>Q10</b>	740-798 MHz	10 / 50	10 / 50

### NOTE

This Radio equipment is intended for use in musical professional entertainment and similar applications.

This Radio apparatus may be capable of operating on some frequencies not authorized in your region. Please contact your national authority to obtain information on authorized frequencies and RF power levels for wireless microphone products.

## RF Carrier Frequency Range

518-865 MHz, depending on region

## Working Range

UR1, UR2: 150 m (500 ft.), under typical conditions  
500 m (1600 ft) **line-of-sight, outdoors  
for a single system**

**NOTE:** Actual working range depends on RF signal absorption, reflection and interference

## Audio Frequency Response

40 – 18,000 Hz, (+1 dB, –3 dB).

**NOTE:** Overall system frequency response depends on the microphone element

## Gain Adjustment Range

UR1: –20 to +35 dB  
UR2: –10 to +20 dB

## Modulation

FM (45 kHz max. deviation), compander system with pre- and de-emphasis

## RF Power Output

See table above.

## Dynamic Range

>105 dB, A-weighted

## Image Rejection

>110 dB typical

## RF Sensitivity

UR4S	UR4D
–110 dBm Typical 12 dB SINAD	–107 dBm Typical 12 dB SINAD
–105 dBm Typical 30 dB SINAD	–102 dBm Typical 30 dB SINAD

## Spurious Rejection

>90 dB typical

## Ultimate Quieting (ref. 45 kHz deviation)

>100 dB, A-weighted

## Signal Polarity

Positive pressure on microphone diaphragm (or positive voltage applied to tip of WA302 phone plug) produces positive voltage on XLR output pin 2 with respect to XLR pin 3 and on the tip of the 1/4-inch output jack.

## System Distortion (ref. ± 45 kHz deviation, 1 kHz modulation)

<0.3% Total Harmonic Distortion typical

## Power Requirements

UR1, UR2: Two 1.5V AA batteries  
UR4: 100 to 240 Vac, 50/60 Hz

## Current Drain

UR1, UR2: 180 mA max. (normal RF power setting)  
240 mA max. (high RF power setting)

UR4D, UR4S: 0.8 Amps max.

## Battery Life (Typical)

UR1, UR2: 9.5 hours (low power)  
6 hours (high power)

## Operating Temperature Range

–18° to +57° C (0° to +135° F)

**NOTE:** Battery characteristics may limit this range

**NOTE:** Electrical safety approval is based on a maximum ambient temperature of 35°C (95°F).

## Overall Dimensions

UR1: 98 mm L x 60 mm W x 17 mm D (3.84 x 2.38 x 0.66 in.)

UR2/SM58: 261 mm L x 51 mm Dia. (10.27 x 2 in.)

UR2/SM86: 261 mm L x 51 mm Dia. (10.27 x 2 in.)

UR2/SM87A: 254 mm x 51 mm Dia. (10 x 2 in.)

UR2/KSM9/BK, UR2/KSM9/SL: 250 mm x 49 mm Dia.  
(9 7/8 x 1 15/16 in.)

UR2/BETA 58: 258 mm L x 51 mm Dia. (10.15 x 2 in.)

UR2/BETA 87A, UR2/BETA 87C: 254 mm x 51 mm  
Dia. (10 x 2 in.)

UR4S/UR4D: 44 mm H x 483 mm W x 366 mm D  
(1.72 x 19.00 x 14.39 in.)

## Net Weight

UR1: 97 g (3.4 oz.) without battery

UR2/SM58: 356 g (12.6 oz.) without battery

UR2/BETA 58: 314 g (11.1 oz.) without battery

UR2/SM86: 317 g (11.2 oz.) without battery

UR2/SM87A: 298 g (10.5 oz.) without battery

UR2/KSM9/BK, UR2/KSM9/SL: 410 g (14.5 oz.) without battery

UR2/BETA 87A, U2/BETA 87C: 325 g (11.5 oz) without battery

UR4S: 4.8 kg (10.6 lbs)

UR4D: 5.0 kg (11.0 lbs)

## Housing:

UR1: Cast magnesium

UR2: Aluminum die-cast handle and aluminum machined battery cup

UR4S, UR4D: Galvanized steel

## Wiring

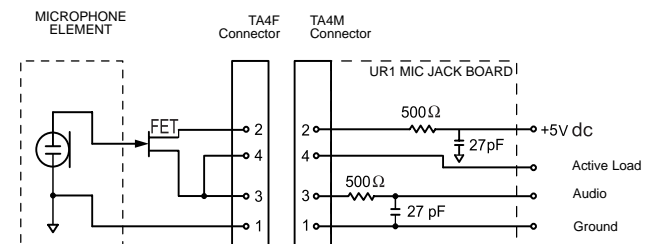

**NOTE:** LAVALIER MIC TIES PINS 3 AND 4 TOGETHER—GUITAR CABLE DOES NOT.

## Inputs and Outputs

### UR1 Transmitter Audio Input

<b>Connector:</b>	4-Pin male mini connector (TA4M)
<b>Input Configuration:</b>	Unbalanced, active
<b>Actual Impedance:</b>	>1 M $\Omega$
<b>Maximum Input Level: 1 kHz, 1% THD</b>	+10 dBu (sensitivity 0 dB) +20 dBu (sensitivity -10 dB)
<b>TA4M Connector Pin Assignments:</b>	Pin 1: Ground Pin 2: +5 Vdc bias Pin 3: Audio Pin 4: Tied through active load (on main board) to Ground. (On instrument adapter cable, Pin 4 floats)

### UR1 Transmitter RF Output

<b>Connector:</b>	SMA
<b>Actual Impedance:</b>	50 $\Omega$
<b>Pin Assignments:</b>	Shell = Ground Center = Signal

### UR2 Transmitter Audio Input

<b>Input Configuration:</b>	Unbalanced, active
<b>Actual Impedance:</b>	>1 M $\Omega$
<b>Maximum Input Level: 1 kHz, 1% THD</b>	+4.8 dBu

### UR2 Transmitter RF Output

<b>Connector:</b>	SMA
<b>Actual Impedance:</b>	50 $\Omega$
<b>Pin Assignments:</b>	Shell = Ground Center = Signal

### Receiver Input

	Antenna	Power
<b>Connector Type:</b>	BNC	IEC
<b>Actual Impedance:</b>	50 $\Omega$	-
<b>Nominal Input Level:</b>	-95 to -30 dBm	100-240 VAC, 50/60 Hz
<b>Maximum Input Level:</b>	-20 dBm	240 VAC, + 10%, 50/60 Hz
<b>Pin Assignments:</b>	Shell = Ground Center = Signal	IEC Standard
<b>Bias Voltage*</b>	12.2 Vdc @ 150 mA maximum	N/A

\* For remote antenna amplifiers

### Receiver Audio Output

	Monitor (1/4" Headphone)	1/4" Phone	XLR
<b>Output Configuration:</b>	Unbalanced mono, 1/4 inch	Impedance Balanced	Electrically Balanced
<b>Actual Impedance:</b>	50 $\Omega$	200 $\Omega$	200 $\Omega$ (active balanced) (150 $\Omega$ mic)
<b>Maximum Output Level</b>	1 Watt @ 63 $\Omega$	+18 dBu	+24 dBu (-6 dBu mic) with 100 Hz modulating tone
<b>Pin Assignments:</b>	Tip = Hot Ring = Hot Sleeve = Gnd	Tip = Hot Ring = no signal Sleeve = Gnd	1 = Ground 2 = Audio + 3 = Audio -
<b>Phantom Power Protection?</b>	No	Yes	Yes

### Computer/Network Interface

Ethernet	USB*
RJ45	USB Series B Receptacle

\* USB-IF logo is a trademark of Universal Serial Bus Implementers Forum, Inc.

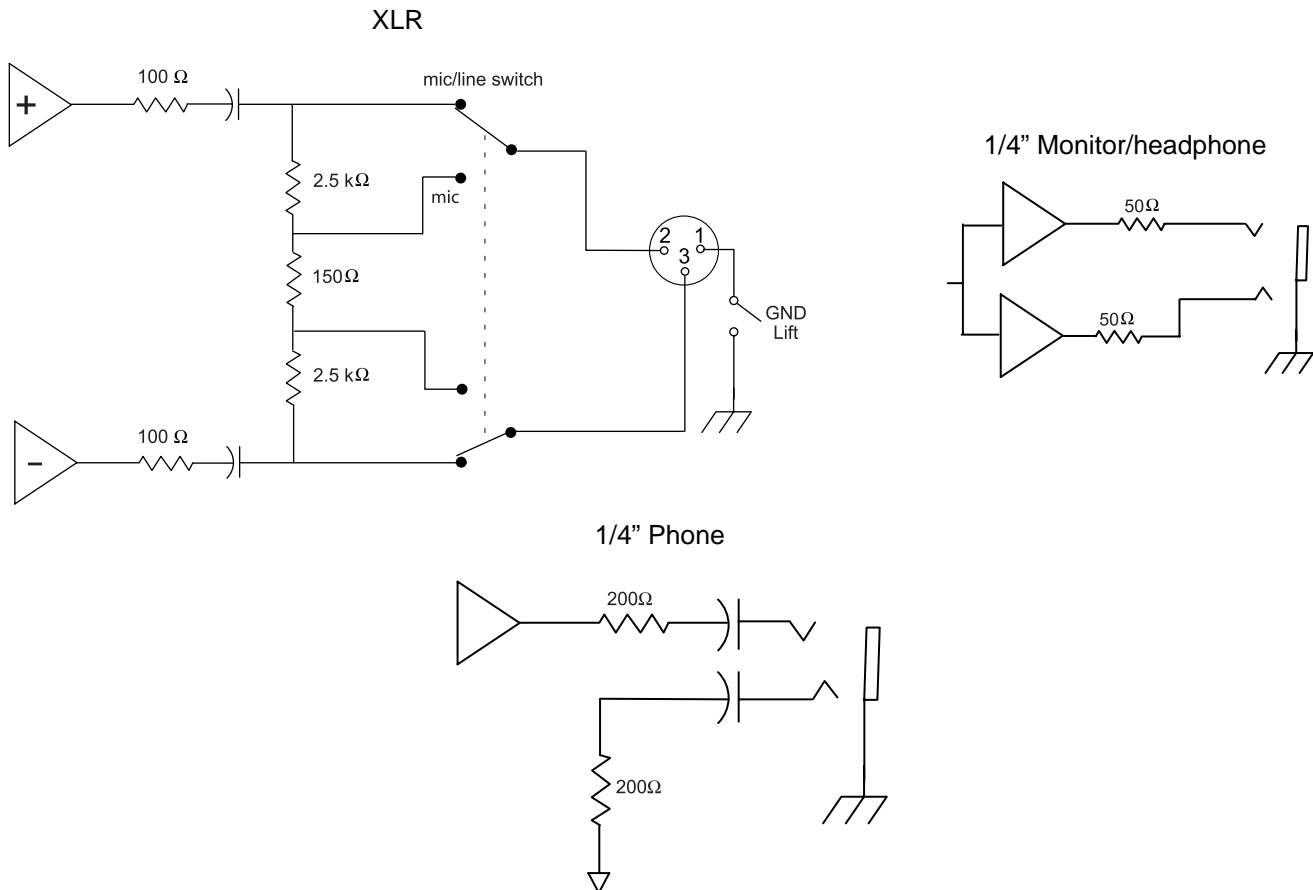

## Replacement Parts and Accessories

### Furnished Accessories

Microphone Stand Adapter (UR2)	WA371
Zipper Bag (UR1)	26A13
Zipper Bag (UR2)	26A14
Antenna Extension Cables (2)	95A9023
Hardware Kit, Locking Connector	WA340
Antenna (UR1), 518-578 MHz	UA710
Antenna (UR1), 578-698 MHz	UA720
Antenna (UR1), 740-865 MHz	UA730
Two Antennas (UR4), Band Dependent (see table)	UA820
Transmitter Carrying Case	95A9053

### Optional Accessories

SM58 Head with Grille	RPW112
SM86 Head with Grille	RPW114
BETA 58 Head with Grille	RPW118
BETA 87A Head with Grille	RPW120
BETA 87C Head with Grille	RPW122
SM87A Head with Grille	RPW116
KSM9/SL Head with Grille	RPW180
KSM9/BK Head with Grille	RPW184
Matte Silver Grille (SM58)	RK143G
Matte Silver Grille (SM86)	RPM266
Matte Silver Grille (BETA 58)	RK265G
Black Grille (SM87)	RK214G
Matte Silver Grille (BETA 87A)	RK312
Matte Silver Grille (BETA 87C)	RK312
Black Grille (BETA 58)	RK323G
Black Grille (BETA 87A/BETA 87C)	RK324G
Popper Stopper™ Windscreen	A85WS
Belt Clip	44A8031
Body-Pack Pouch (Black), UR1	WA580B
Body-Pack Pouch (White), UR1	WA580W

### Architects' and Engineers' Specifications

The wireless system shall operate in the UHF band between 518 MHz and 865 MHz, with the specific range being dependent on the user's locale. The system shall include the option of changing the operating frequency in order to avoid RF interference, enabling up to 108 systems to operate simultaneously in the same location. Preconfigured group, channel and frequency setups shall be available to ensure that multiple systems in use do not interfere with one another.

All transmitters shall be powered by 2 AA batteries and shall have a power on/off switch. The bodypack will have an LED indicating that power is on. Available transmitters shall include: a body pack for use with electric guitars, basses, and other electric instruments, and a handheld microphone for vocals. The transmitters shall have a DC/DC converter to ensure consistent performance, even if battery voltages change.

The receiver shall have a user-programmable, menu-driven LCD showing group, channel, frequency, name, squelch level, and locked/unlocked status. The system shall use technology such as MARCAD® signal combining circuitry to improve reception, minimize signal dropouts, and achieve the best possible signal-to-noise ratio. An equalizer, tone key squelch, and noise squelch circuitry shall be built into the system to provide optimal sound quality and minimize unwanted noise. The receiver shall include dual RF meters (one for each antenna), an audio level meter, and a Networking Interface connector for computer control and monitoring. The receiver shall have a volume control and an adjustable noise squelch control.

The system shall be the Shure UHF-R Wireless.

### Antenna Combiners and Accessories

- Antennas and receivers must be from the same frequency band.
- The supplied 1/2 wave antennas can be remotely mounted or mounted directly to the UA845.
- Antennas and cables for use with the UA845 can also be used with stand-alone UHF-R receivers.

Passive Antenna/Splitter Combiner Kit (recommended for 2 receivers)	UA221
UHF Antenna Power Distribution Amplifier (recommended for 3 or more receivers)	UA845-
U.S.A.	UA845US
Europe	UA845E
UK	UA845UK
1/2 Wave, Omnidirectional, Wideband Antenna	UA860WB
Active Directional Wideband Antenna	UA870WB
Wideband In-Line RF Amplifier	UA830WB
Passive Unidirectional Wideband Antenna	PA805WB
1/2 wave antennas (2)	
H4E, H4 Bands	UA820H4
J5E, J5 Bands	UA820J
L3E, L3 Bands	UA820L3
Q5, Q6, Q10 Bands	UA820Q
R9, ABJ Bands	UA820A
25' Antenna Cable (RG-8/X)	UA825
50' Antenna Cable (RG-8/X)	UA850
100' Antenna Cable	UA8100

## Certification

UR1, UR2: Type Accepted under FCC Parts 74 (FCC ID: "DD4UR1" & "DD4UR2"). Certified by IC in Canada under RSS-123 and RSS-102 ("IC: 616A-UR1" and "IC: 616A-UR2"). Meets the essential requirements of the European R&TTE Directive 99/5/EC (ETSI EN 300-422 Parts 1 & 2, EN 301 489 Parts 1 & 9) and is eligible to carry the CE marking. **CE 0682** ①

UR4S, UR4D: Authorized under the Declaration Of Conformity provision of FCC Part 15. Certified under Industry Canada to RSS-123 ("IC: 616A-UR4"). Meets the essential requirements of the European R&TTE Directive 99/5/EC (EN 301 489 Parts 1 & 9, EN 300 422 Parts 1 and 2). Eligible to carry the CE marking. **CE**

Conforms to Australian EMC requirements and is eligible for C-Tick marking. **C N108**

Have been granted the following Country Safety Approvals:

cULus Mark for US and Canada: Meets UL6500 and CSA/CAN E60065. UL GS-Certified to EN60065.

### LICENSING INFORMATION:

Licensing: A ministerial license to operate this equipment may be required in certain areas. Consult your national authority for possible requirements.

Changes or modifications not expressly approved by Shure Incorporated could void your authority to operate the equipment. Licensing of Shure wireless microphone equipment is the user's responsibility, and licensability depends on the user's classification and application, and on the selected frequency. Shure strongly urges the user to contact the appropriate telecommunications authority concerning proper licensing, and before choosing and ordering frequencies.

### Information to User

This equipment has been tested and found to comply with the limits for a Class B digital device, pursuant to Part 15 of the FCC Rules. These limits are designed to provide reasonable protection against harmful interference in a residential installation. This equipment generates, uses and can radiate radio frequency energy and, if not installed and used in accordance with the instructions, may cause harmful interference to radio communications. However, there is no guarantee that interference will not occur in a particular installation. If this equipment does cause harmful interference to radio or television reception, which can be determined by turning the equipment off and on, the user is encouraged to try to correct the interference by one or more of the following measures:

- Reorient or relocate the receiving antenna.
- Increase the separation between the equipment and receiver.
- Connect the equipment into an outlet on a circuit different from that to which the receiver is connected.
- Consult the dealer or an experienced radio/TV technician for help.

This Class B digital apparatus complies with Canadian ICES-003.

Cet appareil numérique de la classe B est conforme à la norme NMB-003 du Canada.

Operation of this device is subject to the following two conditions: (1) this device may not cause interference, and (2) this device must accept any interference, including interference that may cause undesired operation of the device.

**Note:** EMC conformance testing is based on the use of supplied and recommended cable types. The use of other cable types may degrade EMC performance

**SYSTEM COMPATIBILITY GUIDE FOR FREQUENCY BANDS H4, H4E, J5, J5E, L3, L3E, Q5, Q9, R9, A24, JBX, Q6 AND Q10  
 SYSTÈMES COMPATIBLES EN FRÉQUENCE DANS LA BANDES H4, H4E, J5, J5E, L3, L3E, Q5, Q9, R9, A24, JBX, Q6 ET Q10  
 FREQUENZKOMPATIBLE SYSTEME IM FREQUENZBEREICH H4, H4E, J5, J5E, L3, L3E, Q5, Q9, R9, A24, JBX, Q6 UND Q10  
 SISTEMAS CON FRECUENCIAS COMPATIBLES EN LAS BANDAS H4, H4E, J5, J5E, L3, L3E, Q5, Q9, R9, A24, JBX, Q6 Y Q10  
 SISTEMI COMPATIBILI IN FREQUENZA NELLA BANDAS H4, H4E, J5, J5E, L3, L3E, Q5, Q9, R9, A24, JBX, Q6 E Q10  
 SISTEMAS COM FREQUÊNCIAS COMPATÍVEIS DA NA FAIXA H4, H4E, J5, J5E, L3, L3E, Q5, Q9, R9, A24, JBX, Q6 E Q10**

**H4 FREQUENCY BAND (518.000 - 578.000 MHz)**

	TV 22 & 27	TV 23 & 28	TV 24 & 29	TV 25 & 30	TV 26 & 31	All Bands	All Bands	Full Spectrum	Full Spectrum	Full Spectrum
Channel	Group 1	Group 2	Group 3	Group 4	Group 5	Group 6	Group 7	Group 8	Group 9	Group 10
1	518.350	524.350	530.350	536.350	542.350	519.000	519.250	518.100	518.900	518.050
2	518.850	524.850	530.850	536.850	542.850	519.425	521.625	518.825	519.625	518.550
3	519.575	525.575	531.575	537.575	543.575	522.100	525.800	519.350	520.150	519.500
4	520.500	526.500	532.500	538.500	544.500	524.525	526.375	520.375	521.175	519.900
5	521.625	527.625	533.625	539.625	545.625	525.525	528.075	521.725	522.525	520.750
6	522.450	528.450	534.450	540.450	546.450	526.075	533.950	522.350	523.150	523.750
7	523.075	529.075	535.075	541.075	547.075	527.325	535.500	525.150	525.950	530.500
8	523.475	529.475	535.475	541.475	547.475	528.100	538.350	530.250	531.050	532.600
9	548.125	554.125	560.125	566.125	572.125	537.475	542.400	530.675	531.475	534.150
10	548.650	554.650	560.650	566.650	572.650	540.450	543.475	532.750	533.550	538.925
11	549.675	555.675	561.675	567.675	573.675	541.600	547.350	534.625	535.425	541.750
12	551.025	557.025	563.025	569.025	575.025	544.925	553.625	543.475	544.275	545.500
13	551.750	557.750	563.750	569.750	575.750	551.625	561.075	544.700	545.500	546.425
14	552.150	558.150	564.150	570.150	576.150	553.300	565.700	547.325	548.125	547.875
15	552.975	558.975	564.975	570.975	576.975	555.300	569.050	548.775	549.575	550.500
16	553.600	559.600	565.600	571.600	577.600	557.075	570.775	549.700	550.500	551.725
17						561.100	571.550	553.450	554.250	560.575
18						566.000	572.800	556.275	557.075	562.450
19						567.550	573.425	561.050	561.850	564.525
20						574.475	573.825	562.600	563.400	564.950
21						518.350	519.875	564.700	565.500	570.050
22						544.325	520.275	571.450	572.250	572.850
23						548.550	522.425	574.450	575.250	573.475
24						554.050	546.925	575.300	576.100	574.825
25						559.900	555.750	575.700	576.500	575.850
26						520.125	521.050	576.650	577.450	576.375
27						535.025	536.475	577.150	577.950	577.100
28						550.450	537.250	523.850	524.650	522.450
29						573.625	539.250	548.300	549.100	546.900
30						575.850	544.000	572.750	573.550	571.350
31						522.650	548.950	529.350	530.150	524.425
32						531.375	552.050	533.950	534.750	528.625
33						538.475	561.975	537.925	538.725	529.675
34						539.100	566.200	561.950	562.750	533.250
35						554.450	567.125	565.525	566.325	557.275
36						564.775	575.050	566.575	567.375	561.250
37								570.775	571.575	565.850
38								535.750	536.550	525.775
39								551.700	552.500	543.500
40								569.425	570.225	559.450

**J5 FREQUENCY BAND (578.000 - 607.975 - 614.025 - 638.000 MHz)**

	TV 32 & 37	TV 33 & 38	TV 34 & 39	TV 35 & 40	TV 36 & 41	All Bands	All Bands	Full Spectrum	Full Spectrum	Full Spectrum
Channel	Group 1	Group 2	Group 3	Group 4	Group 5	Group 6	Group 7	Group 8	Group 9	Group 10
1	578.350	584.350	590.350	596.350	602.350	578.625	581.650	578.375	578.125	578.100
2	578.850	584.850	590.850	596.850	602.850	579.125	586.625	579.400	578.550	579.125
3	579.575	585.575	591.575	597.575	603.575	584.825	588.025	581.750	579.200	581.475
4	580.500	586.500	592.500	598.500	604.500	586.475	592.275	582.625	580.600	582.350
5	581.625	587.625	593.625	599.625	605.625	587.750	595.225	584.675	581.150	584.400
6	582.450	588.450	594.450	600.450	606.450	588.500	597.675	587.350	584.500	587.075
7	583.075	589.075	595.075	601.075	607.075	592.950	601.750	588.825	585.375	588.550
8	583.475	589.475	595.475	601.475	607.475	598.975	602.175	589.225	588.950	588.950
9		614.125	620.125	626.125	632.125	599.875	604.300	594.200	591.175	593.925
10		614.650	620.650	626.650	632.650	615.900	607.675	594.725	593.925	594.450
11		615.675	621.675	627.675	633.675	617.600	614.425	596.975	595.225	596.700
12		617.025	623.025	629.025	635.025	618.400	620.650	603.475	604.150	603.200
13		617.750	623.750	629.750	635.750	621.350	622.025	606.050	604.875	605.775
14		618.150	624.150	630.150	636.150	621.750	623.800	607.725	606.275	607.450
15		618.975	624.975	630.975	636.975	627.925	625.000	616.200	618.025	615.925
16		619.600	625.600	631.600	637.600	629.975	630.175	619.250	620.825	618.975
17						631.025	632.250	620.600	621.975	620.325
18						633.175	633.750	622.525	625.325	622.250
19						635.050	636.275	628.650	627.250	628.375
20						636.650	637.075	630.200	630.500	629.925
21						585.400	587.450	631.175	632.325	630.900
22						587.300	598.975	632.375	633.100	632.100
23						602.025	627.775	632.875	635.275	632.600
24						616.425	632.825	635.825	636.175	635.550
25						619.975	637.575	636.900	636.700	636.625
26						591.225	583.175	637.625	637.700	637.350
27						603.075	588.950	581.200	582.425	580.925
28						605.650	590.825	586.450	587.650	586.175
29						628.625	596.900	592.725	588.050	592.450
30						631.700	599.425	597.900	598.350	597.625
31						580.225	600.700	598.600	599.575	598.325
32						592.500	614.975	604.000	600.600	603.725
33						601.575	616.700	605.350	603.700	605.075
34						606.075	619.525	614.450	607.075	614.175
35						607.575	623.050	615.600	614.925	615.325
36						633.650	635.775	617.150	615.600	616.875
37								620.175	617.025	619.900
38								621.725	619.900	621.450
39								623.850	622.500	623.575
40								634.225	631.150	633.950

**L3 FREQUENCY BAND (638.000 - 698.000 MHz)**

	<b>TV 42 &amp; 47</b>	<b>TV 43 &amp; 48</b>	<b>TV 44 &amp; 49</b>	<b>TV 45 &amp; 50</b>	<b>TV 46 &amp; 51</b>	<b>All Bands</b>	<b>All Bands</b>	<b>Full Spectrum</b>	<b>Full Spectrum</b>	<b>Full Spectrum</b>
<b>Channel</b>	<b>Group 1</b>	<b>Group 2</b>	<b>Group 3</b>	<b>Group 4</b>	<b>Group 5</b>	<b>Group 6</b>	<b>Group 7</b>	<b>Group 8</b>	<b>Group 9</b>	<b>Group 10</b>
1	638.350	644.350	650.350	656.350	662.350	643.775	649.800	638.100	638.900	638.050
2	638.850	644.850	650.850	656.850	662.850	644.375	650.800	638.825	639.625	638.550
3	639.575	645.575	651.575	657.575	663.575	651.900	653.000	639.350	640.150	639.500
4	640.500	646.500	652.500	658.500	664.500	654.150	659.550	640.375	641.175	639.900
5	641.625	647.625	653.625	659.625	665.625	660.375	660.775	641.725	642.525	640.750
6	642.450	648.450	654.450	660.450	666.450	661.125	661.350	642.350	643.150	643.750
7	643.075	649.075	655.075	661.075	667.075	662.875	665.425	645.150	645.950	650.500
8	643.475	649.475	655.475	661.475	667.475	664.300	668.050	650.250	651.050	652.600
9	668.125	674.125	680.125	686.125	692.125	667.125	675.575	650.675	651.475	654.150
10	668.650	674.650	680.650	686.650	692.650	669.500	679.750	652.750	653.550	658.925
11	669.675	675.675	681.675	687.675	693.675	679.000	683.450	654.625	655.425	661.750
12	671.025	677.025	683.025	689.025	695.025	683.525	684.875	663.475	664.275	665.500
13	671.750	677.750	683.750	689.750	695.750	688.825	686.800	664.700	665.500	666.425
14	672.150	678.150	684.150	690.150	696.150	689.750	691.750	667.325	668.125	667.875
15	672.975	678.975	684.975	690.975	696.975	690.425	692.300	668.775	669.575	670.500
16	673.600	679.600	685.600	691.600	697.600	691.500	693.050	669.700	670.500	671.725
17						693.525	693.500	673.450	674.250	680.575
18						694.725	695.550	676.275	677.075	682.450
19						697.075	696.200	681.050	681.850	684.525
20						697.575	697.100	682.600	683.400	684.950
21						649.125	645.875	684.700	685.500	690.050
22						658.825	658.800	691.450	692.250	692.850
23						662.200	663.675	694.450	695.250	693.475
24						677.025	664.800	695.300	696.100	694.825
25						682.675	678.400	695.700	696.500	695.850
26						650.050	646.825	696.650	697.450	696.375
27						651.450	648.050	697.150	697.950	697.100
28						671.075	651.275	643.850	644.650	642.450
29						677.600	657.075	668.300	669.100	666.900
30						695.200	662.350	692.750	693.550	691.350
31						647.450	674.950	649.350	650.150	644.425
32						648.400	679.350	653.950	654.750	648.625
33						666.000	680.750	657.925	658.725	649.675
34						675.900	682.500	681.950	682.750	653.250
35						679.525	685.450	685.525	686.325	677.275
36						696.250	689.700	686.575	687.375	681.250
37								690.775	691.575	685.850
38								655.750	656.550	645.775
39								671.700	672.500	663.500
40								689.425	690.225	679.450

**Q9 FREQUENCY BAND (740.000-805.975 MHz)**

	TV 59 & 64	TV 60 & 65	TV 61 & 66	TV 62 & 67	TV 63 & 68	TV 59 & 62 & 69	TV 60 & 65 & 68	Full Spectrum	Full Spectrum	Full Spectrum
Channel	Group 1	Group 2	Group 3	Group 4	Group 5	Group 6	Group 7	Group 8	Group 9	Group 10
1	740.350	746.350	752.350	758.350	764.350	740.050	746.075	740.025	741.075	740.225
2	740.850	746.850	752.850	758.850	764.850	740.575	746.925	740.725	742.325	740.925
3	741.575	747.575	753.575	759.575	765.575	742.000	747.325	742.100	743.300	742.300
4	742.500	748.500	754.500	760.500	766.500	743.725	748.075	744.775	745.000	744.975
5	743.625	749.625	755.625	761.625	767.625	744.625	749.775	745.375	745.875	745.575
6	744.450	750.450	756.450	762.450	768.450	745.250	750.275	746.525	746.350	746.725
7	745.075	751.075	757.075	763.075	769.075	758.300	751.250	750.475	747.925	750.675
8	745.475	751.475	757.475	763.475	769.475	758.700	751.875	751.475	748.700	751.675
9	770.125	776.125	782.125	788.125	794.125	759.425	776.125	753.425	758.975	753.625
10	770.650	776.650	782.650	788.650	794.650	760.750	776.550	753.900	763.100	754.100
11	771.675	777.675	783.675	789.675	795.675	761.750	779.100	766.125	765.025	766.325
12	773.025	779.025	785.025	791.025	797.025	763.600	780.100	770.925	766.500	771.125
13	773.750	779.750	785.750	791.750	797.750	800.175	780.775	771.625	772.200	771.825
14	774.150	780.150	786.150	792.150	798.150	800.875	781.875	773.200	772.775	773.400
15	774.975	780.975	786.975	792.975	798.975	801.275	795.200	773.775	774.350	773.975
16	775.600	781.600	787.600	793.600	799.600	802.125	796.550	779.475	775.050	779.675
17						803.825	797.325	780.950	779.850	781.150
18						804.325	798.850	782.875	792.075	783.075
19						805.300	799.750	787.000	792.550	787.200
20						805.900		797.275	794.500	797.475
21								798.050	795.500	798.250
22								799.625	799.450	799.825
23								800.100	800.600	800.300
24								800.975	801.200	801.175
25								802.675	803.875	802.875
26								803.650	805.250	803.850
27								804.900	805.950	805.100
28								743.925	740.050	741.375
29								767.450	762.275	744.175
30								779.875	766.100	754.975
31								783.700	778.525	755.375
32								805.925	802.050	756.075
33								754.725	741.800	759.675
34								756.725	749.200	768.475
35								759.275	775.475	769.400
36								770.500	786.700	769.975
37								796.775	789.250	778.750
38								804.175	791.250	782.000
39								757.775	747.400	784.750
40								768.425	761.650	786.775
41								769.800	767.425	787.825
42								778.550	776.175	791.875
43								784.325	777.550	798.750
44								798.575	788.200	804.300

### H4E FREQUENCY BAND (518.000 - 578.000 MHz)

	Full Range max. # of comp. frequ- encies (option 1)	Full Range max. # of comp. frequ- encies (option 2)	France preferred: User Group A (option 1)	France preferred: User Group A (option 2)	France preferred: User Group B (option 1)	France preferred: User Group B (option 2)	France preferred: User Group C (option 1)	France preferred: User Group C (option 2)	All Bands	All Bands
Channel	Group 1	Group 2	Group 3	Group 4	Group 5	Group 6	Group 7	Group 8	Group 9	Group 10
1	518.100	518.900	518.750	518.750	518.100	518.500	520.225	518.300	518.500	518.575
2	518.825	519.625	519.500	519.500	521.500	520.025	522.025	519.000	522.250	520.300
3	519.350	520.150	521.250	520.500	522.975	522.225	522.775	522.025	523.675	521.750
4	520.375	521.175	523.250	521.750	525.700	522.975	525.900	524.000	524.500	522.300
5	521.725	522.525	524.250	523.250	532.500	524.900	526.300	530.025	526.350	526.350
6	522.350	523.150	527.500	526.750	532.900	530.225	533.500	532.700	528.000	527.525
7	525.150	525.950	535.250	527.250	534.500	536.775	535.000	533.500	528.500	527.975
8	530.250	531.050	536.500	531.500	538.975	540.900	536.225	533.900	531.900	531.800
9	530.675	531.475	543.750	537.250	544.775	545.500	541.500	542.300	535.075	535.400
10	532.750	533.550	547.750	547.500	546.975	549.300	550.300	546.775	542.700	536.275
11	534.625	535.425	548.250	550.750	550.100	550.500	557.100	549.900	543.425	540.975
12	543.475	544.275	550.750	554.500	561.500	556.500	560.975	560.225	552.550	547.975
13	544.700	545.500	552.500	562.500	565.300	556.900	562.775	560.975	553.725	551.225
14	547.325	548.125	561.750	563.500	565.700	568.025	568.225	568.225	565.425	551.950
15	548.775	549.575	567.500	569.250	568.025	570.975	570.775	570.775	566.025	552.950
16	549.700	550.500	571.250	571.750	572.500	572.900	572.000	572.700	568.125	557.250
17	553.450	554.250	574.750	572.250	574.100	573.700	572.700	573.100	571.675	558.400
18	556.275	557.075	575.750	575.750	576.025	576.025	574.300	574.300	572.150	558.800
19	561.050	561.850	577.250	576.500	577.500	577.500	576.975	576.975	573.675	561.800
20	562.600	563.400	577.750	577.750	520.775	518.100	520.975	520.975	576.650	568.375
21	564.700	565.500	520.500	528.500	534.100	525.300	525.100	528.225	536.075	525.650
22	571.450	572.250	521.750	529.250	538.225	528.775	536.975	540.700	556.975	553.600
23	574.450	575.250	530.500	530.500	540.900	533.300	540.000	544.225	560.575	567.575
24	575.300	576.100	531.250	538.500	541.700	533.700	542.300	550.300	519.125	523.575
25	575.700	576.500	534.750	540.250	546.225	546.225	556.000	556.000	521.700	533.050
26	576.650	577.450	537.250	543.750	549.700	549.700	556.700	556.700	539.550	556.700
27	577.150	577.950	540.250	544.500	552.025	552.025	557.900	557.100	554.600	566.125
28	523.850	524.650	546.500	545.750	560.775	554.975	566.300	557.900	558.050	572.000
29	548.300	549.100	551.500	551.500	564.500	565.700	575.000	562.775	539.025	518.050
30	572.750	573.550	554.500	552.500	566.500	568.775	576.225	566.300	540.725	536.675
31	529.350	530.150	555.500	556.250	573.700	572.500			545.100	538.375
32	533.950	534.750	560.500	558.750					556.125	571.175
33	537.925	538.725	563.500	559.750					557.400	573.100
34	561.950	562.750	564.250	567.500					570.000	575.250
35	565.525	566.325	569.250	568.500						
36	566.575	567.375	570.500	569.750						
37	570.775	571.575								
38	535.750	536.550								
39	551.700	552.500								
40	569.425	570.225								

### J5E FREQUENCY BAND (578.000 - 638.000 MHz)

	Full Range max. # of comp. frequ- encies (option 1)	Full Range max. # of comp. frequ- encies (option 2)	France preferred: User Group A (option 1)	France preferred: User Group A (option 2)	France preferred: User Group B (option 1)	France preferred: User Group B (option 2)	France preferred: User Group C (option 1)	France preferred: User Group C (option 2)	All Bands	All Bands
Channel	Group 1	Group 2	Group 3	Group 4	Group 5	Group 6	Group 7	Group 8	Group 9	Group 10
1	578.375	578.375	578.500	578.500	578.225	578.225	578.775	580.000	589.375	581.050
2	579.400	579.100	579.250	579.250	578.975	578.975	580.000	580.700	590.525	582.400
3	581.750	580.175	579.750	582.750	580.900	580.900	582.300	581.100	591.175	583.950
4	582.625	583.125	583.250	583.250	582.500	581.300	583.000	581.900	595.300	584.950
5	584.675	583.625	585.750	585.750	585.500	582.500	584.975	584.975	596.350	585.700
6	587.350	584.825	587.500	591.750	593.500	586.975	589.100	591.000	600.375	589.250
7	588.825	585.800	593.250	593.250	594.975	592.025	592.225	594.775	601.875	589.900
8	589.225	587.350	595.500	595.500	597.300	598.500	597.100	597.500	602.825	591.125
9	594.200	593.475	598.750	604.250	604.900	606.100	597.900	605.900	604.925	593.350
10	594.725	595.400	610.500	607.500	605.700	608.775	605.500	606.300	605.700	599.100
11	596.975	596.750	611.250	608.500	606.100	609.500	608.975	608.225	616.900	610.300
12	603.475	599.800	615.500	609.250	610.975	610.975	610.775	610.775	622.650	611.075
13	606.050	608.275	623.250	617.750	624.775	620.900	621.500	621.100	624.875	613.175
14	607.725	609.950	623.750	623.250	626.975	624.775	623.000	624.975	626.100	614.125
15	616.200	612.525	625.750	623.750	628.900	628.900	628.000	626.775	626.750	615.625
16	619.250	619.025	631.750	625.750	630.500	630.500	628.700	631.000	630.300	619.650
17	620.600	621.275	633.250	633.250	636.500	634.225	634.775	634.025	631.050	620.700
18	622.525	621.800	634.500	634.500	636.900	634.975	636.700	634.775	632.050	624.825
19	628.650	626.775	635.500	635.500	637.700	637.300	637.100	636.000	633.600	625.475

**J5E FREQUENCY BAND (578.000 - 638.000 MHz) (Continued)**

Channel	Group 1	Group 2	Group 3	Group 4	Group 5	Group 6	Group 7	Group 8	Group 9	Group 10
20	630.200	627.175	636.250	636.250	580.500	637.700	637.900	637.500	634.950	626.625
21	631.175	628.650	583.750	580.250	584.775	586.225	578.025	584.225	594.000	586.250
22	632.375	631.325	585.250	587.750	596.900	588.500	594.025	596.000	620.625	595.375
23	632.875	633.375	599.500	590.750	598.100	589.300	594.775	598.300	629.750	622.000
24	635.825	634.250	600.500	594.500	598.500	600.025	596.700	605.100	579.850	593.850
25	636.900	636.600	601.750	599.750	600.775	604.500	606.300	608.975	580.950	607.800
26	637.625	637.625	602.500	601.750	610.225	605.700	610.025	620.700	586.800	629.200
27	581.200	581.775	603.750	602.500	616.775	614.100	621.900	621.900	608.200	635.050
28	586.450	592.150	606.750	603.500	621.700	621.700	626.775	622.300	622.150	636.150
29	592.725	594.275	608.500	611.250	626.225	626.225	630.300	624.225	598.250	581.900
30	597.900	595.825	609.250	615.500	630.100	626.975	631.000	630.300	606.250	598.100
31	598.600	598.850	612.250	619.250	634.225	630.100			611.900	603.050
32	604.000	600.400	619.500	620.250	634.975	636.500			612.950	604.100
33	605.350	601.550	620.250	625.250					617.900	609.750
34	614.450	610.650	625.250	626.500					634.100	617.750
35	615.600	612.000	626.500	631.500						
36	617.150	617.400	633.750	632.500						
37	620.175	618.100								
38	621.725	623.275								
39	623.850	629.550								
40	634.225	634.800								

**L3E FREQUENCY BAND (638.00 - 698.000 MHz)**

	Full Range max. # of comp. frequencies (option 1)	Full Range max. # of comp. frequencies (option 2)	France preferred: User Group A (option 1)	France preferred: User Group A (option 2)	France preferred: User Group B (option 1)	France preferred: User Group B (option 2)	France preferred: User Group C (option 1)	France preferred: User Group C (option 2)	All Bands	All Bands
Channel	Group 1	Group 2	Group 3	Group 4	Group 5	Group 6	Group 7	Group 8	Group 9	Group 10
1	638.100	638.900	639.500	639.500	640.775	638.500	640.225	639.000	647.625	639.350
2	638.825	639.625	640.500	640.500	642.225	640.775	640.975	640.225	654.200	642.325
3	639.350	640.150	641.250	641.750	645.300	645.300	642.025	640.975	657.200	643.850
4	640.375	641.175	641.750	643.250	646.100	650.225	644.700	642.025	657.600	644.325
5	641.725	642.525	643.250	643.750	648.025	650.975	646.300	644.700	658.750	647.875
6	642.350	643.150	646.750	647.250	650.975	652.900	653.100	652.700	663.050	649.975
7	645.150	645.950	651.500	655.500	660.500	654.100	653.500	653.100	664.050	650.575
8	650.250	651.050	655.500	657.250	660.900	654.500	656.975	660.000	664.775	662.275
9	650.675	651.475	667.250	665.750	662.100	658.225	661.100	662.300	668.025	663.450
10	652.750	653.550	672.500	671.750	668.500	670.500	666.025	668.700	675.025	672.575
11	654.625	655.425	673.750	672.500	672.775	678.100	666.775	669.500	679.725	673.300
12	663.475	664.275	679.250	675.250	680.025	680.775	680.225	680.975	680.600	680.925
13	664.700	665.500	679.750	676.250	681.500	682.975	682.025	685.900	684.200	684.100
14	667.325	668.125	681.250	682.500	690.975	684.900	685.500	687.000	688.025	687.500
15	668.775	669.575	683.750	684.250	692.900	686.500	688.225	692.700	688.475	688.000
16	669.700	670.500	687.500	687.500	694.100	692.900	692.000	693.900	689.650	689.650
17	673.450	674.250	692.250	691.750	694.500	693.700	692.700	694.300	693.700	691.500
18	676.275	677.075	695.500	695.750	696.775	696.025	693.100	696.225	694.250	692.325
19	681.050	681.850	696.500	697.250	697.500	697.500	693.900	696.975	695.700	693.750
20	682.600	683.400	697.250	697.750	638.100	638.100	696.975	650.775	697.425	697.500
21	684.700	685.500	638.750	641.250	648.775	644.900	652.000	656.225	648.425	655.425
22	691.450	692.250	647.250	647.750	650.225	648.775	658.025	663.000	662.400	659.025
23	694.450	695.250	649.250	648.500	661.700	657.500	658.775	664.975	690.350	679.925
24	695.300	696.100	649.750	657.750	666.225	666.975	668.000	672.225	644.000	657.950
25	695.700	696.500	650.500	658.500	666.975	669.300	680.975	682.775	649.875	661.400
26	696.650	697.450	660.250	662.750	669.300	670.100	684.700	685.100	659.300	676.450
27	697.150	697.950	662.750	663.500	669.700	672.775	685.900	686.300	682.950	694.300
28	643.850	644.650	664.500	665.250	682.225	684.500			692.425	696.875
29	668.300	669.100	666.500	667.500	685.700	692.500			640.750	646.000
30	692.750	693.550	671.500	671.250	686.100	694.100			642.900	658.600
31	649.350	650.150	674.500	674.500					644.825	659.875
32	653.950	654.750	684.250	688.500					677.625	670.900
33	657.925	658.725	689.750	689.250					679.325	675.275
34	681.950	682.750	691.750	691.250					697.950	676.975
35	685.525	686.325	697.750	695.250						
36	686.575	687.375								
37	690.775	691.575								
38	655.750	656.550								
39	671.700	672.500								
40	689.425	690.225								

**Q5 FREQUENCY BAND (740.000 - 814.000 MHz)**

	Full Range max. # of comp. frequencies (option 1)	Full Range max. # of comp. frequencies (option 2)	Full Range max. # of comp. frequencies (option 3)	Full Range max. # of comp. frequencies (option 4)	France preferred: User Group A (option 1)	France preferred: User Group A (option 2)	France preferred: User Group A (option 3)	France preferred: User Group B (option 1)	France preferred: User Group B (option 2)	France preferred: User Group B (option 3)
Channel	Group 1	Group 2	Group 3	Group 4	Group 5	Group 6	Group 7	Group 8	Group 9	Group 10
1	740.300	740.425	740.100	740.625	740.250	740.250	742.750	740.900	740.500	740.900
2	740.825	740.850	740.625	741.050	742.750	743.250	743.500	741.300	740.900	741.300
3	742.400	742.100	742.200	742.300	743.250	743.750	745.250	742.100	742.100	746.975
4	742.800	742.650	742.600	742.850	744.500	745.250	746.500	744.025	744.025	748.900
5	745.000	744.025	744.800	744.225	746.500	746.500	747.500	745.500	744.775	749.700
6	745.975	744.675	745.775	744.875	747.250	753.750	751.750	749.300	746.225	752.025
7	748.850	745.600	748.650	745.800	752.500	755.500	753.250	754.225	756.900	753.500
8	749.950	750.050	749.750	750.250	759.750	763.500	753.750	760.025	761.500	764.500
9	753.350	752.625	753.150	752.825	767.500	769.250	758.750	770.975	764.500	768.775
10	756.100	753.525	755.900	753.725	768.500	771.250	771.750	774.100	770.975	774.100
11	764.875	758.825	764.675	759.025	769.750	772.250	775.500	774.500	772.900	776.025
12	770.150	766.275	769.950	766.475	771.750	774.750	776.500	781.300	773.300	778.975
13	771.800	769.350	771.600	769.550	772.250	775.500	777.750	782.500	776.775	781.700
14	772.575	770.025	772.375	770.225	786.500	785.750	787.500	784.025	778.225	782.500
15	774.325	771.300	774.125	771.500	794.500	791.750	791.500	786.225	778.975	784.775
16	776.625	777.375	776.425	777.575	796.250	795.500	799.750	786.975	796.500	796.500
17	782.700	779.675	782.500	779.875	799.750	800.500	801.750	802.975	797.700	800.775
18	783.975	781.425	783.775	781.625	803.500	801.250	803.250	806.100	806.500	804.500
19	784.650	782.200	784.450	782.400	806.750	803.250	804.250	808.025	808.025	805.700
20	787.725	783.850	787.525	784.050	807.500	807.500	807.500	809.500	810.225	810.225
21	795.175	789.125	794.975	789.325	809.750	808.500	809.250	812.500	810.975	810.975
22	800.475	797.900	800.275	798.100	811.750	809.750	809.750	813.300	813.700	812.900
23	801.325	800.650	801.125	800.850	812.250	811.500	810.500	813.700	753.500	813.300
24	803.950	804.050	803.750	804.250	748.250	745.750	744.500	746.225	754.975	744.775
25	808.400	805.150	808.200	805.350	750.750	750.750	745.750	753.500	757.700	746.225
26	809.325	808.025	809.125	808.225	755.750	752.500	751.250	758.100	766.500	750.100
27	809.975	809.000	809.775	809.200	759.250	753.250	754.500	758.500	781.700	765.300
28	811.350	811.200	811.150	811.400	762.500	754.500	755.500	765.300	788.500	768.025
29	811.900	811.600	811.700	811.800	763.500	758.750	759.500	768.775	789.300	772.500
30	813.150	813.175	812.950	813.375	766.750	760.500	760.500	769.500	792.025	773.700
31	813.575	813.700	813.375	813.900	770.500	767.500	766.750	772.900	792.775	781.300
32	754.400	751.050	754.200	751.250	775.500	770.500	770.500	788.900	797.300	792.025
33	768.000	772.025	767.800	772.225	779.500	776.500	771.250	797.300	798.500	794.975
34	778.000	776.000	777.800	776.200	782.750	777.750	779.500	801.500	800.775	797.300
35	781.975	786.000	781.775	786.200	783.250	779.250	782.750			
36	802.950	799.600	802.750	799.800	784.500	782.750	784.500			
37	743.550	746.200	743.350	746.400	785.250	784.500	785.250			
38	750.400	755.625	750.200	755.825	788.250	785.250	785.750			
39	751.425	768.400	751.225	768.600	791.750	786.500	786.500			
40	785.600	802.575	785.400	802.775	795.500	788.250	790.750			
41	798.375	803.600	798.175	803.800	798.750	796.250	793.250			
42	807.800	810.450	807.600	810.650	800.500	801.750	800.500			
43	767.400	754.825	767.200	755.025	808.500	810.500	808.500			
44	768.950	758.375	768.750	758.575	810.500	812.250	812.250			
45	769.700	763.725	769.500	763.925						
46	790.275	784.300	790.075	784.500						
47	795.625	785.050	795.425	785.250						
48	799.175	786.600	798.975	786.800						

**Q5 (Continued)**

	France preferred: User Group C (option 1)	France preferred: User Group C (option 2)	France preferred: User Group C (option 3)	Germany preferred: User Group 1 790-814 MHz	Germany preferred: User Group 2 790-814 MHz	Germany preferred: User Group 3A 790-814 MHz	Germany preferred: User Group 3B 790-814 MHz	Germany preferred: User Group 3C 790-814 MHz	Germany preferred: User Group 3D 790-814 MHz	Germany preferred: User Group 4 790-814 MHz
Channel	Group 11	Group 12	Group 13	Group 14	Group 15	Group 16	Group 17	Group 18	Group 19	Group 20
1	741.100	740.700	741.100	790.100	790.100	790.250	790.300	790.350	790.400	791.475
2	741.900	741.100	741.500	791.050	791.575	792.325	791.250	791.300	790.800	792.525
3	742.300	742.300	742.300	793.575	792.050	792.900	792.950	794.925	798.800	793.200
4	743.000	743.000	744.975	794.675	794.425	793.725	794.875	795.450	803.500	795.625
5	748.700	750.300	746.025	803.200	796.250	795.350	795.400	801.000	804.725	797.125
6	751.000	752.975	748.000	804.425	797.500	799.900	796.150	803.450	805.700	802.525
7	754.025	757.900	752.225	806.100	799.575	800.900	798.700	806.350	806.400	804.850
8	765.500	759.000	757.500	806.500	806.600	807.200	801.775	806.750	808.475	805.250
9	768.225	770.775	759.000	811.200	809.325	810.825	807.950	808.425	809.050	808.550
10	768.975	772.700	773.100	811.950	810.425	812.100	808.375	809.825	809.875	809.950
11	770.025	774.300	773.500	813.400	812.950	812.575	809.775	813.650	810.975	811.550
12	775.000	778.025	776.225	813.900	813.900	794.825	812.625	793.825	792.475	812.850
13	778.775	781.100	776.975	796.425	790.600	808.325	806.700	796.675	793.875	813.775
14	780.700	782.300	780.000	797.400	805.500	811.350	810.875	797.650	794.975	799.400

**Q5 (Continued)**

15	783.000	784.975	781.900	797.900	805.900		811.400	809.000	795.500	810.525
16	797.500	786.775	784.225	800.750	808.800		813.600	810.925	796.725	
17	797.900	797.900	788.700							
18	799.000	800.225	802.025							
19	805.100	804.000	804.700							
20	806.300	805.100	805.100							
21	808.225	807.000	805.900							
22	808.975	808.225	810.025							
23	810.775	812.700	812.000							
24	813.100	813.500	813.500							
25	746.775	744.225	752.975							
26	749.100	748.700	754.025							
27	752.225	749.100	756.700							
28	754.775	752.225	774.300							
29	756.700	754.775	782.300							
30	764.000	764.000	788.000							
31	782.300	768.225	789.100							
32	784.225	772.000	789.900							
33	784.975	780.700	792.975							
34	788.000	791.000	802.775							
35	792.225	794.025	806.300							
36	813.900	794.775	810.775							

**Q5 (Continued)**

	Germany preferred: User Group 4 790-814 MHz (option 2)	Germany preferred: Fixed Installations 742-790 MHz	Optimized: TV oh. 55 742-750 MHz	Optimized: TV oh. 56 750-758 MHz	Optimized: TV oh. 57 758-766 MHz	Optimized: TV oh. 58 766-774 MHz	Optimized: TV oh. 59 774-782 MHz	Broad-casters preferred: TV oh. 60 782-790 MHz	Optimized: TV oh. 61 790-798 MHz	Optimized: TV oh. 62 798-806 MHz	Netherlands preferred: TV oh. 63 806-814 MHz	Combined UHF-R Q5 and R9: max. # of compatible	Combined UHF-R Q5 and R9: max. # of compatible
Channel	Group 21	Group 22	Group 23	Group 24	Group 25	Group 26	Group 27	Group 28	Group 29	Group 30	Group 31	Group 32	Group 33
1	790.925	742.750	742.100	750.100	758.100	766.100	774.100	782.225	790.100	798.100	806.100	742.000	740.175
2	791.400	744.625	742.925	750.925	758.925	766.925	774.925	782.650	790.925	798.925	806.925	743.200	740.900
3	792.625	745.100	743.525	751.525	759.525	767.525	775.525	783.900	791.525	799.525	807.525	743.850	742.300
4	795.025	745.975	744.575	752.575	760.575	768.575	776.575	784.625	792.575	800.575	808.575	744.800	742.850
5	795.650	747.650	745.900	753.900	761.900	769.900	777.900	785.775	793.900	801.900	809.900	748.175	743.975
6	797.050	748.225	747.650	755.650	763.650	771.650	779.650	786.400	795.650	803.650	811.650	748.650	746.550
7	802.000	753.225	748.050	756.050	764.050	772.050	780.050	787.325	796.050	804.050	812.050	749.500	747.550
8	803.575	754.750	749.200	757.200	765.200	773.200	781.200	787.850	797.200	805.200	813.200	751.250	751.525
9	805.750	755.950	749.900	757.900	765.900	773.900	781.900	788.675	797.900	805.900	813.900	752.750	751.925
10	810.300	759.350	746.600	754.600	762.600	770.600	778.600		794.600	802.600	810.600	758.025	765.325
11	811.050	762.275										760.925	766.550
12	812.850	770.100										770.900	767.425
13	813.775	774.375										774.450	773.025
14	799.400	775.775										776.400	773.525
15	808.550	777.500										777.475	776.625
16		779.750										778.875	777.950
17		782.550										783.075	781.950
18		784.475										796.800	783.775
19		785.975										797.975	798.600
20		787.050										804.325	804.250
21		788.350										806.225	808.800
22		788.875										741.200	748.175
23		743.500										773.450	752.600
24		772.075										775.700	770.875
25		755.450										810.100	778.900
26		756.750										745.475	783.375
27		770.825										754.900	766.125
28		772.725										762.625	771.775
29		776.450										768.825	786.450
30		789.875										783.575	802.075
31		760.000										797.575	812.900
32		783.925										755.525	745.950
33												756.650	749.375
34												758.975	763.475
35												781.700	788.125
36												807.675	800.900

**R9 FREQUENCY BAND (790.000-865.000 MHz)**

	Full Range max. # of compatible frequencies (option 1)	Full Range max. # of compatible frequencies (option 2)	Full Range max. # of compatible frequencies (option 3)	Full Range max. # of compatible frequencies (option 4)	Optimized: TV oh. 61-63 & TV oh. 67-69 & EU harmonized: 790-814 & 838-862 MHz & 863-865 MHz	Optimized: TV oh. 61-63 & TV oh. 69 & EU harmonized: 790-814 & 854-862 MHz & 863-865 MHz	Germany preferred: User Group 4 790-814 MHz & 838-865 MHz (only indoor)	Germany preferred: User Group 4 790-814 MHz & 854-865 MHz (indoor and outdoor)	Germany preferred: User Group 3A 790-814 MHz & 838-865 MHz	Germany preferred: User Group 3B 790-814 MHz & 838-865 MHz	Germany preferred: User Group 3C 790-814 MHz & 838-865 MHz
Channel	Group 1	Group 2	Group 3	Group 4	Group 5	Group 6	Group 7	Group 8	Group 9	Group 10	Group 11
1	790.650	791.300	790.725	790.525	790.175	790.525	792.550	792.625	790.250	791.950	790.350
2	791.900	792.050	791.825	791.125	793.025	791.775	794.000	793.175	792.325	793.775	791.300
3	794.200	793.225	792.500	791.925	793.425	792.400	794.525	794.025	792.900	794.875	794.925
4	795.275	793.875	794.950	794.025	798.225	793.550	797.200	795.625	793.725	798.300	796.675
5	795.975	795.375	795.375	795.850	799.100	796.150	799.400	797.750	794.825	800.950	800.425
6	797.425	798.050	796.900	798.125	799.600	797.100	801.200	801.225	799.200	806.300	805.650
7	797.975	798.475	801.725	801.725	800.675	803.025	802.175	805.100	799.900	806.700	806.350
8	802.175	800.925	802.675	802.750	801.325	804.500	805.750	807.425	804.100	808.375	808.425
9	803.725	805.425	803.975	803.225	805.975	805.000	809.125	810.100	810.825	811.400	809.000
10	804.650	806.700	804.750	809.975	809.900	807.225	811.575	810.525	812.100	812.150	809.825
11	808.600	809.050	809.275	816.025	810.875	810.525	812.825	811.600	812.575	813.600	811.450
12	814.550	812.050	817.225	818.000	813.450	812.100	813.250	813.300	839.200	838.300	839.300
13	817.550	823.825	820.550	818.575	838.175	813.450	840.625	854.950	839.900	840.375	840.425
14	823.625	825.000	823.175	819.375	838.975	854.325	841.425	856.625	840.325	840.950	841.825
15	828.275	826.550	827.825	821.500	840.125	854.975	843.725	857.475	842.825	841.775	843.450
16	829.100	829.700	829.375	822.400	841.875	855.900	845.100	857.950	844.100	843.400	849.000
17	830.625	831.500	829.875	828.575	843.225	857.700	845.800	859.050	846.250	846.700	852.675
18	831.625	832.550	830.625	829.250	847.975	858.850	848.525	859.725	847.200	847.950	853.650
19	833.275	842.775	834.825	830.275	850.975	860.750	849.125	861.175	856.900	855.950	858.925
20	833.875	844.100	842.650	835.075	851.475	863.175	853.800	861.750	857.725	856.950	859.450
21	841.575	846.575	844.050	843.050	853.125	864.000	855.400	791.450	860.100	860.150	860.675
22	846.050	851.125	845.900	851.975	855.625	864.475	857.950	801.950	795.350	860.625	793.825
23	851.950	853.475	853.025	852.800	857.475	792.825	859.650	805.775	807.200	791.250	801.000
24	855.900	857.750	855.000	855.125	861.475	795.750	861.150	863.525	807.900	795.400	806.750
25	856.825	858.525	855.600	856.475	863.775	805.750	795.700	864.200	811.350	797.600	813.650
26	858.425	858.950	856.725	856.975	864.175	806.300	800.625		856.325	808.950	854.350
27	859.050	860.725	859.050	858.025	864.825	807.875	810.100		859.350	854.700	857.825
28	860.550	863.350	859.450	861.575	790.800	810.975	810.550		860.575	859.400	861.650
29	863.400	863.900	863.625	863.625	794.350	811.700	839.475		863.100	863.125	863.250
30	863.825	864.875	864.350	864.325	794.775	857.225	849.925		863.675	863.750	
31	864.625	794.775	801.000	792.450	804.225	861.300	854.950		864.475	864.825	
32	799.275	799.800	822.000	827.450	805.400		857.200				
33	822.150	825.575	827.200	845.000	806.800		863.200				
34	830.225	827.075	860.975	845.600	808.600		863.675				
35	847.400	845.700	864.875	794.775	811.475						
36	807.375	855.450	791.425	795.175	840.800						
37	810.825	811.600	803.425	806.125	843.850						
38	815.825	813.825	808.825	809.225	844.275						
39	816.300	819.850	834.400	811.875	849.325						
40	820.250	841.075	840.050	813.275	860.725						
41	821.050	845.100	861.950	830.700							
42	839.850	847.800	861.800	831.725							
43	842.400	813.400	807.475	834.425							
44	843.925	816.725	822.425	843.750							
45	845.150	818.975	835.800	847.250							
46	846.625	840.675	840.500	848.375							
47	853.775	856.100	843.525	849.900							

### R9 (Continued)

	Germany preferred: User Group 3D 790-814 MHz & 838-865 MHz	Germany preferred: User Group 2 790-814 MHz & 838-862 MHz	Germany preferred: User Group 1 790-814 MHz & 838-862 MHz	France preferred: User Group A (option 1)	France preferred: User Group A (option 2)	France preferred: User Group B (option 1)	France preferred: User Group B (option 2)	France preferred: User Group C (option 1)	France preferred: User Group C (option 2)	Optimized: TV oh. 61 790-798 MHz	Optimized: TV oh. 62 798-806 MHz
Channel	Group 12	Group 13	Group 14	Group 15	Group 16	Group 17	Group 18	Group 19	Group 20	Group 21	Group 22
1	790.400	790.100	791.050	791.500	790.750	790.500	792.775	790.300	791.000	790.100	798.100
2	791.350	793.325	792.175	792.500	791.750	792.025	794.225	791.000	794.775	790.925	798.925
3	794.975	794.425	792.750	793.750	793.250	794.225	794.975	792.975	797.100	791.525	799.525
4	796.725	796.950	795.200	795.250	793.750	794.975	796.900	797.100	797.500	792.575	800.575
5	800.475	797.900	796.425	795.750	794.500	796.900	798.100	797.900	798.300	793.900	801.900
6	805.700	800.050	799.750	800.500	799.500	797.300	798.500	800.975	802.775	795.650	803.650
7	806.400	806.100	802.675	801.250	801.750	801.500	801.500	806.300	808.975	796.050	804.050
8	808.475	807.575	805.400	807.750	808.500	809.500	806.500	813.500	813.100	797.200	805.200
9	809.050	808.050	806.100	811.250	817.750	812.900	810.975	818.025	820.000	797.900	805.900
10	809.875	808.800	811.950	819.500	820.250	821.300	822.100	820.000	822.300	794.600	802.600
11	811.500	813.500	813.400	822.750	823.250	822.500	824.025	822.300	823.000		
12	839.350	838.100	838.100	824.500	823.750	826.225	826.225	824.975	824.225		
13	840.475	840.050	838.500	825.750	826.500	826.975	826.975	828.000	828.000		
14	841.875	840.800	843.950	827.250	827.500	828.500	829.300	828.700	829.100		
15	843.500	843.825	851.200	828.250	828.250	828.900	829.700	829.100	829.500		
16	849.050	844.250	852.425	790.750	795.500	798.500	805.300	792.225	790.300		
17	852.725	846.100	853.400	798.750	802.500	802.975	809.500	796.700	807.000		
18	853.700	849.325	854.100	799.500	803.750	810.225	812.900	800.225	812.700		
19	858.975	853.900	856.175	809.250	806.750	813.300	813.300	812.700	814.300		
20	859.500	859.825	856.750	810.500	811.500	814.500	814.100	816.975	816.225		
21	860.725	860.950	857.575	812.250	814.750	816.775	822.500	826.025	824.975		
22	793.875	861.500	858.675	815.750	815.500	863.150	863.125	863.150	863.125		
23	801.050	790.600	797.900	816.500	816.500	863.550	863.525	863.550	863.525		
24	806.800	791.575	807.050	817.750	818.500	864.175	864.175	864.175	864.175		
25	813.700	792.800	807.750	823.500	819.750	864.600	864.625	864.600	864.625		
26	854.400	811.250	859.200	863.150	825.250						
27	857.875	811.825	861.400	863.550	863.125						
28	861.700	812.950		864.175	863.525						
29	863.300	855.575		864.600	864.175						
30		856.050			864.625						
31		859.250									

### R9 (Continued)

	Netherlands preferred: TV Ch. 63 806-814MHz (option 1)	Netherlands preferred: TV Ch. 63 806-814MHz (option 2)	Optimized: TV Ch. 61-63 790-814 MHz	FIN preferred: 790-822MHz (option 1)	FIN preferred: 790-822MHz (option 2)	Sweden preferred: 800-814MHz (option 1)	Sweden preferred: 800-814MHz (option 2)	NOR / DEN preferred: 800-820 MHz	Optimized TVchannels: TV Ch. 67 838-846 MHz	Optimized TVchannels: TV Ch. 68 846-854 MHz
Channel	Group 23	Group 24	Group 25	Group 26	Group 27	Group 28	Group 29	Group 30	Group 31	Group 32
1	806.100	806.100	790.150	790.775	790.675	800.300	800.125	800.325	838.100	846.100
2	806.925	806.800	791.200	791.175	791.825	800.700	801.125	801.800	838.925	846.925
3	807.525	807.950	794.200	792.125	792.575	801.975	803.125	802.200	839.525	847.525
4	808.575	808.350	795.375	792.650	794.225	802.500	803.775	802.950	840.575	848.575
5	809.900	810.100	796.875	794.325	794.875	804.075	805.675	805.825	841.900	849.900
6	811.650	811.425	797.825	801.550	796.925	806.950	807.050	807.950	843.650	851.650
7	812.050	812.475	801.650	802.400	800.325	808.325	809.925	810.475	844.050	852.050
8	813.200	813.075	803.350	805.200	805.550	810.225	811.500	811.075	845.200	853.200
9	813.900	813.900	806.125	806.450	806.800	810.875	812.025	812.450	845.900	853.900
10	810.600	809.400	808.675	811.675	809.600	812.875	813.300	814.825	842.600	850.600
11			809.425	815.075	810.450	813.875	813.700	817.800		
12			811.550	817.125	817.675	803.450	804.925	818.300		
13			812.950	817.775	819.350	809.075	810.550	819.575		
14			813.350	819.425	819.875			800.850		
15			790.775	820.175	820.825			804.600		
16			794.900	821.325	821.225			813.250		
17			805.275	794.800	795.325			816.675		
18			806.750	799.400	797.425					
19			807.600	799.900	801.750					
20			810.375	804.200	802.775					
21				807.375	804.625					
22				809.225	807.800					
23				810.250	812.100					
24				814.575	812.600					
25				816.675	817.200					

**R9 (Continued)**

	BEL / TUR / UK preferred: TV Ch. 69 & EU harmonized 854-862 & 863-865 MHz	Optimized: TV Ch. 67-69 & EU harmonized 838-862 & 863-865 MHz	U.K. preferred: "Ch. 69 Co-ordinate frequencies SET 1"	U.K. preferred: "Ch. 69 Co-ordinate frequencies SET 2"	U.K. preferred: "Ch. 69 Co-ordinated frequencies INDOORS"	U.K. preferred: "Ch. 69 Co-ordinated frequencies OUTDOORS"	U.K. preferred: "Ch. 69 Shared frequencies" (option 1)	U.K. preferred: "Ch. 69 Shared frequencies" (option 2)	EU harmonized band: optimized for 863 - 865 MHz	Combined UHF-R Q5 and R9: max. # of compatible (option 1)	Combined UHF-R Q5 and R9: max. # of compatible (option 2)
Channel	Group 33	Group 34	Group 35	Group 36	Group 37	Group 38	Group 39	Group 40	Group 41	Group 42	Group 43
1	854.225	838.650	855.675	856.500	854.500	854.375	854.900	855.275	863.125	791.925	796.050
2	855.525	840.225	856.375	857.500	855.000	854.850	855.900	855.900	863.525	793.425	796.900
3	855.925	841.325	856.800	858.250	855.900	855.725	856.575	857.950	864.175	796.250	798.025
4	856.550	843.700	857.425	858.700	856.600	856.400	857.950	858.650	864.625	802.725	803.000
5	857.950	845.000	860.600	859.525	857.100	856.850	858.650	860.400		808.450	806.700
6	859.550	850.675			857.850	857.625	860.400	860.900		809.450	811.825
7	860.725	852.675			858.900	858.625	861.200	861.750		811.450	812.250
8	861.450	853.250			859.500	859.950	861.750			823.200	815.125
9	864.050	855.150			860.475	860.650				824.350	828.625
10	864.550	856.050			860.925	861.075				826.800	829.500
11	854.750	859.225			861.700	861.900				828.075	836.825
12		860.625								830.800	838.400
13		863.600								837.000	840.425
14		864.400								839.275	846.975
15		864.800								840.850	847.525
16		838.250								850.675	848.725
17		839.625								851.175	851.800
18		843.275								852.850	853.925
19		847.500								854.250	857.425
20		854.475								857.125	861.125
21		857.325								864.475	863.475
22										831.375	803.525
23										852.175	825.125
24										858.975	830.800
25										863.300	853.250
26										805.700	863.900
27										834.350	823.975
28										835.175	831.900
29										835.575	839.300
30										848.800	860.075
31										861.825	864.550
32										791.075	791.525
33										794.225	817.550
34										823.925	825.775
35										848.300	832.425
36										861.025	855.125

**A24 FREQUENCY BAND (779-778 / 797-806)**

Channel	L1	L2	L3	L4	L5	L6	L7	L8
A1	779.125	779.250	779.625	779.750	780.625	780.250	779.125	782.875
A2	779.375	779.500	779.875	780.500	781.125		779.375	783.000
A3	780.125	780.000	780.375	781.000	781.375		779.875	783.125
A4	780.750	780.875	781.250	782.125	781.750		780.500	783.250
A5	782.000	781.500	781.625	782.375	782.625		781.500	783.375
A6	782.500	781.875	782.250	782.750			782.375	783.500
A7							782.750	
1	797.125	797.250	797.625	797.750	798.625	798.250	797.125	800.875
2	797.375	797.500	797.875	798.500	799.125		797.375	801.000
3	798.125	798.000	798.375	799.000	799.375		797.875	801.125
4	798.750	798.875	799.250	800.125	799.750		798.500	801.250
5	800.000	799.500	799.625	800.375	800.625		799.500	801.375
6	800.500	799.875	800.250	800.750			800.375	801.500
7							800.750	

Channel	H1	H2	H3	H4	H5	H6	H7	H8
A1	783.625	783.750	784.125	784.250	785.125	784.750	783.625	787.375
A2	783.875	784.000	784.375	785.000	785.625		783.875	787.500
A3	784.625	784.500	784.875	785.500	785.875		784.375	787.625
A4	785.250	785.375	785.750	786.625	786.250		785.000	787.750
A5	786.500	786.000	786.125	786.875	787.125		786.000	787.875
A6		786.375	786.750	787.250			786.875	
A7							787.250	
1	801.625	801.750	802.125	802.250	803.125	802.750	801.625	805.375
2	801.875	802.000	802.375	803.000	803.625		801.875	805.500
3	802.625	802.500	802.875	803.500	803.875		802.375	805.625
4	803.250	803.375	803.750	804.625	804.250		803.000	805.750
5	804.500	804.000	804.125	804.875	805.125		804.000	805.875
6	805.000	804.375	804.750	805.250			804.875	
7							805.250	

Channel	C1	C2	C3	C4	C5	C6	C7	C8	C9
1	779.125	779.500	779.250	779.500	779.125	779.250	779.250	779.250	779.500
2	779.375	779.875	779.750	780.000	779.375	779.500	780.000	780.750	780.250
3	780.875	782.375	780.500	780.750	780.125	780.000	780.500	781.625	780.750
4	781.875	784.125	782.000	782.250	781.625	781.375	781.500	782.000	781.750
5	783.750	786.500	782.625	784.000	783.625	782.500	781.875	783.625	782.125
6	786.125	787.500	783.750	785.375	784.250	783.375	784.000	784.250	784.250
7	787.250	787.750	785.750	786.000	785.375	784.875	785.625	785.375	785.875
8			786.750	787.000	786.625	786.125	786.750	786.750	787.000
9					787.000	786.500	787.375	787.250	787.625
10					787.500	787.125	787.625	787.500	787.875

Channel	E1	E2	E3	E4	E5	E6	E7	E8	E9
1	797.125	797.500	797.250	797.500	797.125	797.250	797.250	797.250	797.500
2	797.375	797.875	797.750	798.000	797.375	797.500	798.000	798.750	798.250
3	798.875	800.375	798.500	798.750	798.125	798.000	798.500	799.625	798.750
4	799.875	802.125	800.000	800.250	799.625	799.375	799.500	800.000	799.750
5	801.750	804.500	800.625	802.000	801.625	800.500	799.875	801.625	800.125
6	804.125	805.500	801.750	803.375	802.250	801.375	802.000	802.250	802.250
7	805.250	805.750	803.750	804.000	803.375	802.875	803.625	803.375	803.875
8			804.750	805.000	804.625	804.125	804.750	804.750	805.000
9					805.000	804.500	805.375	805.250	805.625
10					805.500	805.125	805.625	805.500	805.875

Channel	F1	F2	F3	F4	F5	F6	F7	F8	F9
1	797.125	797.250	799.000	797.625	797.375	797.125	797.375	797.250	797.125
2	797.875	797.500	800.125	798.000	797.750	797.375	797.625	797.500	797.500
3	798.250	798.750	801.500	799.000	798.875	797.750	798.875	797.875	799.125
4	799.750	799.500	803.500	800.250	801.625	798.750	799.250	799.625	800.125
5	801.875	802.250	804.250	802.000	804.125	799.875	800.250	801.000	802.000
6	802.875	802.750	805.875	803.500		801.375	801.000	802.250	804.250
7	804.250	805.125				803.625	803.000	803.875	804.750
8						804.375	805.250	805.000	805.500
9						804.875		805.875	

**JBX FREQUENCY BAND (806-125, 809.750 MHz)**

Channel	Group 1	Group 2	Group 3	Group 4	Group 5	Group 6	Group 7
1	806.125	806.250	806.625	806.750	807.625	807.250	806.125
2	806.375	806.500	806.875	807.500	808.125		806.375
3	807.125	807.000	807.375	808.000	808.375		806.875
4	807.750	807.875	808.250	809.125	808.750		807.500
5	809.000	808.500	808.625	809.375	809.625		808.500
6	809.500	808.875	809.250	809.750			809.375
7							809.750

Channel	F1	F2	F3	F4	F5	F6	F7	F8	F9
1									
2									
3									
4									
5									
6					806.125				
7			806.375	807.000	806.375				
8	806.250	807.625	808.125	807.250	807.125				
9	806.750	808.750	809.000	807.750	807.750		806.125		808.000
10	809.500	809.375	809.375	808.875	809.000	806.750	808.500	806.875	808.625
11	809.750	809.750	809.625	809.750	809.500	808.750	809.125	808.375	809.500
12						809.625	809.625	809.125	809.750

**Q6 FREQUENCY BAND (740.125 - 751.875 MHz)**

Channel	Group 1	Group 2	Group 3	Group 4	Group 5
1	740.275	740.275	740.250	740.275	740.375
2	741.000	740.825	740.900	740.800	741.275
3	741.450	741.725	741.325	742.550	741.700
4	742.425	742.250	742.075	743.350	743.450
5	742.850	742.975	743.025	743.775	743.925
6	743.600	743.450	743.475	745.525	744.775
7	744.050	744.425	744.525	748.125	746.975
8	745.050	746.825	745.375	748.925	748.700
9	747.450	747.825	747.925	749.350	749.600
10	748.425	748.275	748.375	751.250	750.925
11	748.900	749.025	749.200	751.775	751.650
12	749.625	749.450	749.625		
13	750.150	750.425	750.250		
14	751.050	750.875	751.100		
15	751.600	751.600	751.600		

**Q10 FREQUENCY BAND (740.000 - 797.900)**

	Works with UA G1	Works with UA G2	Works with UA G3	Works with UA G4	Works with UA G5	Works with UA G6	Works with UA G7	Full Spectrum	Full Spectrum	Full Spectrum
Channel	Group 1	Group 2	Group 3	Group 4	Group 5	Group 6	Group 7	Group 8	Group 9	Group 10
1	740.450	740.600	740.550	740.075	741.350	740.550	740.300	740.000	741.075	740.200
2	741.425	742.500	740.975	740.500	742.150	744.350	741.400	740.625	743.000	740.825
3	743.075	743.000	742.750	742.025	745.725	744.975	741.925	742.450	743.600	742.650
4	745.350	744.050	747.875	747.550	747.000	745.800	742.825	742.975	745.225	743.175
5	746.050	744.700	748.750	748.800	748.050	749.100	745.800	743.800	749.100	744.000
6	747.350	746.700	753.225	749.650	749.525	755.175	747.950	746.625	756.175	746.825
7	748.150	749.000	754.225	753.650	750.700	756.250	749.475	748.825	759.850	749.025
8	751.875	752.125	755.550	756.800	753.550	756.725	752.575	749.225	761.000	749.425
9	753.625	754.650	756.325	760.550	755.325	758.725	755.925	755.750	762.800	755.950
10	756.050	756.100	758.200	761.500	756.700	759.450	756.550	759.075	763.825	759.275
11	757.150	757.900	758.825	762.200	758.300	761.650	758.325	761.025	767.325	761.225
12	763.525	760.925	762.550	763.350	758.700	766.225	761.525	769.125	768.175	769.325
13	764.950	768.675	767.425	765.850	768.800	771.450	766.775	769.725	768.775	769.925
14	749.725	741.700	741.750	767.850	745.000	741.675	746.625	770.575	776.875	770.775
15	752.350	746.150	743.475	741.150	751.425	753.425	747.150	774.075	778.825	774.275
16	754.650	747.950	746.650	744.200	757.375	754.425	750.750	775.100	782.150	775.300
17	756.750	756.850	751.350	746.100	759.650	760.425	753.775	776.900	788.675	777.100
18	761.400	758.700	751.925	752.525	760.325	772.225	757.775	778.050	789.075	778.250
19	762.675	759.250	753.625	754.400	764.400	792.275	759.825	781.725	791.275	781.925
20		761.975	792.150	755.775	779.675	795.000	776.575	788.800	794.100	789.000
21				766.975	789.350		779.600	792.675	794.925	792.875
22				784.550	790.350			794.300	795.450	794.500
23					791.850			794.900	797.275	795.100
24					792.650			796.825	797.900	797.025
25								747.325	740.575	747.525
26								750.000	754.950	750.200
27								782.950	787.900	783.150
28								797.325	790.575	797.525
29								763.450	745.850	763.650
30								763.925	754.200	764.125
31								764.650	772.325	764.850
32								765.575	773.250	765.775
33								783.700	773.975	783.900
34								792.050	774.450	792.250
35								741.675	747.900	741.875
36								761.750	751.825	761.950
37								786.075	776.150	786.275
38								790.000	796.225	790.200

## EU DECLARATION OF CONFORMITY

We,  
of

Shure Incorporated  
5800 Touhy Avenue  
Niles, Illinois, 60714-4608 U.S.A.  
Phone: (847) 600-2000  
Web: [www.Shure.com](http://www.Shure.com)

Declare under our sole responsibility that the following product

Model: UR1, UR2

Description: Body Pack and Handheld UHF Transmitters

Model: UR4S, UR4D

Description: UHF Receivers

conforms to the essential requirements and other relevant provisions of the R&TTE Directive (1999/5/EC).

The products comply with the following product family, harmonized or national standards:

EN 301 489-1 V1.4.1 (2002-08)

EN 301 489-9 V1.2.1 (2002-08)

EN 300 422-1 V1.2.2 (2000-08)

EN 300 422-2 V1.1.1 (2000-08)

In addition, the UR4S and UR4D products comply with the following product family, harmonized or national standard;

EN60065

EN61000-3-2:2000 Amendment A1:1998; A2:1998; A14:2000

EN 61000-3-3 Amendment A1:2001

The technical documentation is kept at:

Shure Incorporated, Corporate Quality Engineering Division  
SHURE Europe GmbH, EMEA Approval

Manufacturer: Shure Incorporated

Signed:  Date: 6 January 2005

Name and Title: Craig Kozokar, EMC Project Engineer, Corporate Quality Engineering Division

European Representative: SHURE Europe GmbH

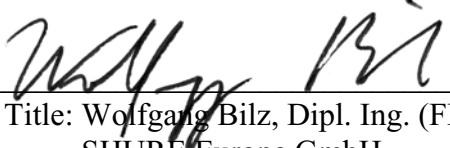
Signed:  Date: 6 January 2005

Name and Title: Wolfgang Bilz, Dipl. Ing. (FH), EMEA Approval

SHURE Europe GmbH

Headquarters Europe, Middle East & Africa

Wannenäcker Str. 28

D-74078 Heilbronn, Germany

Phone: +49 - (0)7131 - 7214 - 0

Fax: +49 - (0)7131 - 7214 - 14

### FCC DECLARATION OF CONFORMITY

We,  
of

Shure Incorporated  
5800 W. Touhy Avenue  
Niles, IL 60714-4608, U.S.A.  
(847) 600-2000

Declare under our sole responsibility that the following product

Model: UR4S and UR4D Description: UHF Receivers

Has been tested and found to comply with the limits for an unintentional radiator device, and approved under the Declaration of Conformity provision of the Part 15 of the FCC rules.

Operation is subject to the following two conditions:

1. This device may not cause harmful interference.
2. This device must accept any interference received, including interference that may cause undesired operation.

Signed

Date January 6 2005



Name, Title

Craig Kozokar

EMC Project Engineer, Corporate Quality, Shure Incorporated

## SHURE®

SHURE Incorporated <http://www.shure.com>  
United States, Canada, Latin America, Caribbean:  
5800 W. Touhy Avenue, Niles, IL 60714-4608, U.S.A.  
Phone: 847-600-2000 U.S. Fax: 847-600-1212 Intl Fax: 847-600-6446  
Europe, Middle East, Africa:  
Shure Europe GmbH, Phone: 49-7131-72140 Fax: 49-7131-721414  
Asia, Pacific:  
Shure Asia Limited, Phone: 852-2893-4290 Fax: 852-2893-4055



## CAUTION: Public Safety Restrictions

Avoid the following groups, channels, and frequency ranges as specified for each listed metro region.

NOTE: This information is known to be accurate at the time of printing but is subject to change. Check the Shure website for the latest public safety frequency and channel information:

Metro Region	Groups, Showing Channels to Avoid										Frequency (Mhz) to Avoid	TV Channels to Avoid
	G1	G2	G3	G4	G5	G6	G7	G8	G9	G10		
Boston, MA	1-8		1-8			1-6, 12	1-6, 11-13	1-6, 11-13	1-6, 11-14		470-476, 482-488	14, 16
Chicago, IL - North Western Indiana, Cleveland, OH	1-8					1-11	1-10				470-476, 476-482	14, 15
Dallas-Fort Worth, TX			1-8			12	11-13	11-14			482-488	16
Detroit, MI		1-8				7-12	7-13	7-14			476-482, 482-488	15, 16
Houston, TX				1-8		13-17	14-19	15-16	15-17	15-16	488-494	17
Los Angeles, CA	1-8	9-16	1-8			1-6, 12 27-30	1-6, 11-13, 27-30	1-6, 11-14, 26-29			470-476, 482-488, 506-512	14, 16, 20
Miami, FL	1-8						1-6				470-476	14
New York, NY - Northeastern New Jersey	1-8					1-12	1-13	1-14			470-476, 476-482, 482-488	14, 15, 16
Philadelphia, PA, New Jersey	9-16					21-30		22-29			500-506, 506-512	19, 20
Pittsburgh, PA	1-8				1-8	1-6, 18-20	1-6, 20	1-6, 17-21	1-6, 18-21	1-6, 17-21	470-476, 494-500	14, 18
San Francisco Oakland, CA			1-8			12-17	11-19	11-16	11-17	11-16	482-488, 488-494	16, 17
Washington, D.C., Maryland, Virginia				1-8		13-20	14-20	15-21			488-494, 494-500	17, 18

## FURNISHED ACCESSORIES

Receiver Antennas (UR4S/UR4D):

UA820G 1/2 Wave Omnidirectional Antenna G1 470-530Mhz

Bodypack Antennas (UR1):

UA700 Omnidirectional Whip Antenna for UR1 Bodypack Transmitters G1 470-530Mhz

## INTER-GROUP AVAILABILITY: UHF-R G1 470-530MHZ

Please read the Caution: Public Safety Restriction on Page 1.

The following table describes compatible Frequencies and Channels available within each group.

Channel	Group 1	2	3	4	5	6	7	8	9	10
	TV 14 & 19	TV 15 & 20	TV 16 & 21	TV 17 & 22	TV 18 & 23	G1, H4, J5 and L3 bands completely available		Full G1 spectrum		
1	470.350	476.350	482.350	488.350	494.350	470.400	470.475	470.250	470.125	470.375
2	470.850	476.850	482.850	488.850	494.850	471.375	471.875	470.875	470.750	471.000
3	471.575	477.575	483.575	489.575	495.575	472.125	472.350	471.775	471.650	471.900
4	472.500	478.500	484.500	490.500	496.500	473.500	473.525	473.075	472.950	473.200
5	473.625	479.625	485.625	491.625	497.625	474.050	474.500	474.025	473.900	474.150
6	474.450	480.450	486.450	492.450	498.450	475.225	475.750	475.700	475.575	475.825
7	475.075	481.075	487.075	493.075	499.075	477.200	476.300	476.525	476.400	476.650
8	475.475	481.475	487.475	493.475	499.475	478.750	477.750	476.975	476.850	477.100
9	500.125	506.125	512.125	518.125	524.125	479.375	478.825	478.600	478.475	478.725
10	500.650	506.650	512.650	518.650	524.650	479.775	479.425	479.425	479.300	479.550
11	501.675	507.675	513.675	519.675	525.675	481.900	482.325	483.475	483.350	483.600
12	503.025	509.025	515.025	521.025	527.025	482.700	484.725	483.900	483.775	484.025
13	503.750	509.750	515.750	521.750	527.750	488.850	486.150	484.575	484.450	484.700
14	504.150	510.150	516.150	522.150	528.150	489.525	488.025	485.050	484.925	485.175
15	504.975	510.975	516.975	522.975	528.975	489.975	488.675	489.450	489.325	489.575
16	505.600	511.600	517.600	523.600	529.600	492.225	489.600	491.875	491.750	492.000
17						493.625	490.900	494.100	493.975	494.225
18						494.275	491.900	495.650	495.525	495.775
19						495.275	493.975	496.575	496.450	496.700
20						496.025	498.775	497.725	497.600	497.850
21						501.475	500.800	498.450	498.325	498.575
22						502.325	501.250	500.550	500.425	500.675
23						502.975	502.000	500.950	500.825	501.075
24						503.425	503.975	501.625	501.500	501.750
25						504.125	504.625	503.900	503.775	504.025
26						505.075	505.025	508.325	508.200	508.450
27						506.425	506.275	510.275	510.150	510.400
28						508.200	506.925	510.900	510.775	511.025
29						509.100	508.250	511.850	511.725	511.975
30						509.650	510.950	513.075	512.950	513.200
31								514.100	513.975	514.225
32								514.600	514.475	514.725
33								518.675	518.550	518.800
34								519.350	519.225	519.475
35								520.425	520.300	520.550
36								521.800	521.675	521.925
37								522.550	522.425	522.675
38								523.525	523.400	523.650
39								526.050	525.925	526.175
40								527.375	527.250	527.500
41								528.025	527.900	528.150
42								529.300	529.175	529.425
43								529.750	529.625	529.875

## INTER-GROUP AVAILABILITY: UHF-R X1 944-952MHZ

The following table describes compatible Frequencies and Channels available within each of 10 Groups.

Channel	Full band, Robust Compatibility, 9 channels			Full band, Maximum frequencies, 11 channels						
	Group 1	2	3	4	5	6	7	8	9	10
1	944.225	944.275	944.775	944.150	944.250	944.175	944.200	944.150	944.200	944.175
2	945.250	944.725	945.225	944.550	944.650	944.700	944.975	944.775	945.050	944.700
3	945.925	946.100	946.600	945.325	945.250	945.675	945.550	945.175	945.575	945.625
4	947.375	947.125	947.400	945.825	946.500	946.200	946.650	945.800	946.475	946.350
5	948.275	948.375	948.650	946.700	947.025	946.950	947.350	946.625	947.175	947.350
6	949.825	949.200	949.350	947.775	948.150	947.450	948.525	947.875	947.625	947.800
7	950.275	950.325	950.350	948.450	949.025	948.900	949.400	948.700	948.325	948.875
8	951.075	950.875	950.925	949.450	949.600	949.525	949.950	949.750	949.950	949.675
9	951.625	951.800	951.825	949.950	950.575	949.925	950.750	950.375	950.400	950.200
10				950.750	951.350	951.150	951.150	951.400	951.325	951.150
11				951.775	951.850	951.800	951.750	951.850	951.825	951.775

## FURNISHED ACCESSORIES

Receiver Antennas (UR4S/UR4D)

UA820X 1/2 Wave Omnidirectional Antenna X1 944-952Mhz

Bodypack Antennas (UR1)

UA740 Omnidirectional Whip Antenna for UR1 Bodypack Transmitters X1 944-952Mhz

## COMPLIANCE INFORMATION

Type accepted under FCC Part 74, FCC ID DD4UR2A. Type accepted under FCC Part 74, FCC ID DD4UR1A.

### Specifications:

The following specifications apply to the UR1M micro bodypack only.

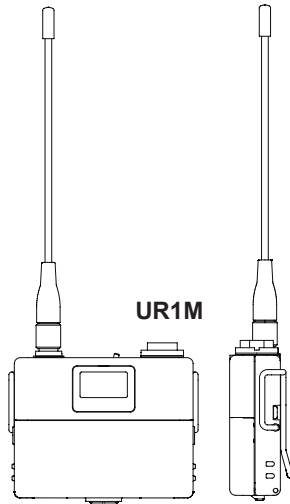

### Features:

- Same audio performance as UR1
- Rapid two-way infrared (IR) data transmission
- User-adjustable RF output level (10 mW or 50 mW)
- Operates with three types of primary batteries: alkaline, lithium or NiMH
- Audio signal is input through a TA4F connector (UR1M) or a LEMO connector (UR1MLEMO3)
- Selectable battery metering by battery type
- Audio metering on UR1M transmitter

Frequency Range	
Band	Range
G1	470-530 MHz
H4, H4E	518-578 MHz
J5	578-608, 614-638 MHz
J5E	578-638 MHz
L3, L3E	638-698 MHz
Q5	740-814 MHz
Q6	740-752 MHz
Q9	740-806 MHz
Q10A	740-787 MHz
R9	790-865 MHz
R16, R18	794-806 MHz
A24	779-788, 797-806 MHz
JBX	806-810 MHz
X1	944-952 MHz

### RF Carrier Frequency Range

470-865, 944-952 MHz depending on region

### Working Range

150 m (500 ft.), under typical conditions 500 m (1600 ft.) **line-of-sight, outdoors for a single system**

**NOTE:** Actual working range depends on RF signal absorption, reflection and interference

### RF Power Output

Selectable 10 mW or 50 mW depending on region

### Power Requirements:

Two 1.5V AAA alkaline, lithium primary, and NiMH batteries

### Current Drain:

130 mA max. at 3V (normal RF power setting)

200 mA max. at 3V (high RF power setting)

### Gain Adjustment Range

-20 to +35 dB

### Battery Life (Typical):

<b>Alkaline:</b>	6 hours (normal RF power) 4 hours (high RF power)
<b>Lithium primary:</b>	9 hours (normal RF power) 7 hours (high RF power)
<b>NiMH 1000 mAH:</b>	6 hours (normal RF power) 4 hours (high RF power)

### Select Battery Type:

Set the micro bodypack transmitter switch to **ON**

Press **enter** key, then scroll using **▼** button to select battery type. Press **enter** key to confirm.

**Note:** For the most accurate battery metering and performance, make sure to select the correct battery type.

To open the micro bodypack transmitter, see illustrations below:

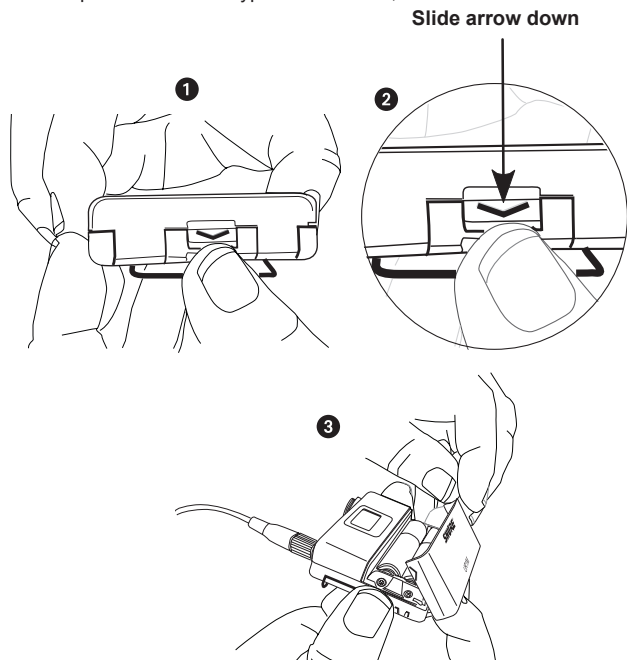

### Transmitter LCD Interface and Controls:

For additional information on the LCD Interface and controls, see UHF-R User Guide.

**Overall Dimensions**

49 mm L x 60 mm W x 17 mm D (1.9 x 2.38 x 0.66 in.)

**Net Weight**

62 g (2.2 oz.) without batteries

**Wiring**

TA4F Connector

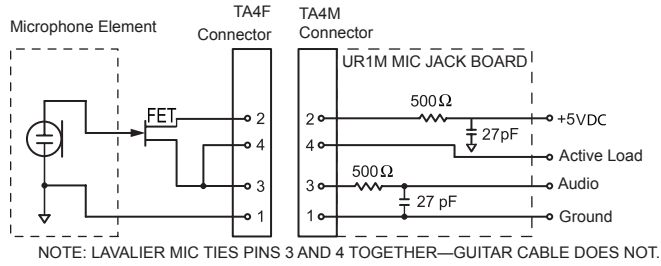

**LEMO Connector**

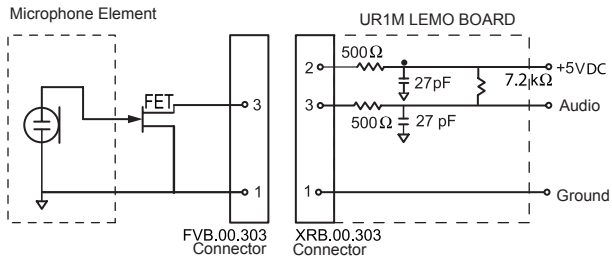

**UR1M Transmitter RF Output:**

Connector:	SMA
Actual Impedance:	50 Ω
Pin Assignments:	Shell = Ground Center = Signal

**UR1M Transmitter Audio Input:**

<b>Connector:</b>	4-Pin male mini connector (TA4M) 3-Pin female mini connector (LEMO XRB.00.303)
<b>Input Configuration:</b>	Unbalanced, active
<b>Maximum Input Level: (1 kHz, 1% THD)</b>	+5 dBu (sensitivity 0 dB) +15 dBu (sensitivity -10 dB)
<b>TA4M Connector Pin Assignments:</b>	Pin 1: Ground Pin 2: +5 VDC bias Pin 3: Audio, 200 kΩ Pin 4: Tied through active load (on main board) to ground. (On instrument adapter cable, Pin 4 floats)
<b>LEMO Connector Pin Assignments:</b>	Pin 1: Ground Pin 2: +5 VDC bias Pin 3: Audio (8.2 kΩ between pin 2 and 3, internal to UR1M)

**REPLACEMENT PARTS AND ACCESSORIES**

**Furnished Accessories**

Antenna, 470-530 MHz.....	UA700
Antenna, 518-578 MHz.....	UA710
Antenna, 578-698 MHz.....	UA720
Antenna, 740-865 MHz.....	UA730
Antenna, 944-952 MHz.....	UA740

**Optional Accessories**

Bodypack Pouch (Black).....	WA581B
Bodypack Pouch (White).....	WA581W
3-Pin mini Lemo conversion kit.....	WA335
3-Pin mini Lemo plug for Lavalier.....	WA336
Assembly Tool for WA336.....	WA337

**Note**

To fully interact with the Receiver, it is recommended to upgrade the UR4 firmware to 1.50 or higher and Shure Wireless Workbench to 5.0

**Certification:**

UR1M: Type Accepted under FCC Parts 74 (FCC ID: DD4UR1MA, DD4UR1MB, DD4UR1MC, DD4UR1MF, DD4UR1MG). Certified by IC in Canada under RSS-123 and RSS-102 (IC: 616A-UR1MA, 616A-UR1MB, 616A-UR1MC). Meets the essential requirements of the European R&TTE Directive 99/5/EC (ETSI EN 300-422 Parts 1 & 2, EN 301 489 Parts 1 & 9) and is eligible to carry the CE marking.

The “EU Declaration of Conformity” can be obtained from Shure Inc. or any of its European representatives. For contact information please visit [www.shure.com](http://www.shure.com)

**LICENSING INFORMATION:**

Licensing: A ministerial license to operate this equipment may be required in certain areas. Consult your national authority for possible requirements. Changes or modifications not expressly approved by Shure Incorporated could void your authority to operate the equipment. Licensing of Shure wireless microphone equipment is the user’s responsibility, and licensability depends on the user’s classification and application, and on the selected frequency. Shure strongly urges the user to contact the appropriate telecommunications authority concerning proper licensing, and before choosing and ordering frequencies.

**Information to User:**

This equipment has been tested and found to comply with the limits for a Class B digital device, pursuant to Part 15 of the FCC Rules. These limits are designed to provide reasonable protection against harmful interference in a residential installation. This equipment generates, uses and can radiate radio frequency energy and, if not installed and used in accordance with the instructions, may cause harmful interference to radio communications. However, there is no guarantee that interference will not occur in a particular installation. If this equipment does cause harmful interference to radio or television reception, which can be determined by turning the equipment off and on, the user is encouraged to try to correct the interference by one or more of the following measures:

- Relocate the receiving antenna.
- Increase the separation between the equipment and receiver.
- Connect the equipment into an outlet on a circuit different from that to which the receiver is connected.
- Consult the dealer

This Class B digital apparatus complies with Canadian ICES-003.

Cet appareil numérique de la classe B est conforme à la norme NMB-003 du Canada.

Operation of this device is subject to the following two conditions:

(1) this device may not cause interference, and (2) this device must accept any interference, including interference that may cause undesired operation of the device.

**Note:** EMC conformance testing is based on the use of supplied and recommended cable types. The use of other cable types may degrade EMC performance.



SHURE Incorporated <http://www.shure.com>  
 United States, Canada, Latin America, Caribbean:  
 5800 W. Touhy Avenue, Niles, IL 60714-4608, U.S.A.  
 Phone: 847-600-2000 U.S. Fax: 847-600-1212 Int'l Fax: 847-600-6446  
 Europe, Middle East, Africa:  
 Shure Europe GmbH, Phone: 49-7131-72140 Fax: 49-7131-721414  
 Asia, Pacific:  
 Shure Asia Limited, Phone: 852-2893-4290 Fax: 852-2893-4055